



LED TV

Chassis : U88A

Model : UE32F6100AW
UE40F6100AW
UE46F6100AW
UE55F6100AW

SERVICE Manual

LED TV



UE**F6100AW

Contents

1. Precautions
2. Product specifications
3. Disassembly and Reassembly
4. Troubleshooting
5. Wiring Diagram

Contents

1. Precautions	1-1
1-1. Safety Precautions	1-1
1-1-1. Warnings.....	1-1
1-1-2. Servicing the LED TV	1-1
1-1-3. Fire and Shock Hazard	1-1
1-1-4. Product Safety Notices	1-2
1-2. Servicing Precautions.....	1-3
1-2-1. General Servicing Precautions	1-3
1-3. Static Electricity Precautions	1-4
1-4. Installation Precautions	1-5
2. Product Specifications	2-1
2-1. Product Specifications	2-1
2-2. Detailed Specifications	2-7
2-2-1. Model Comparison	2-7
2-2-2. Feature & Specifications.....	2-8
2-3. Accessories	2-12
2-4. Viewing the Functions	2-13
2-4-1. Auto Motion Plus 120 Hz	2-13
2-4-2. Supported Formats.....	2-14
2-4-3. 3D Display	2-17
3. Disassembly and Reassembly	3-1
3-1. Disassembly and Reassembly	3-1
3-1-1. LED TV	3-1
3-1-2. ASSY BOARD P-RF-MODULE.....	3-10
4. Troubleshooting	4-1
4-1. Troubleshooting.....	4-1
4-1-1. Previous Check	4-1
4-1-2. Simple flow chart of malfunction.....	4-3
4-2. How to Check Fault Symptom	4-4
4-2-1. NO Power	4-4
4-2-2. No Video (Tuner_CVBS)	4-7
4-2-3. No Vido (Tuner DTV).....	4-10
4-2-4. No Video (Video AV).....	4-13
4-2-5. No Video (COMPONENT).....	4-16
4-2-6. No Sound (1.Speaker 2.Monitor_out 3.Optical).....	4-19
4-3. Factory Mode Adjustments	4-22
4-3-1. Detail Factory Option.....	4-22
4-3-2. Entering Factory Mode	4-23
4-3-3. Factory Data	4-24

4-4. White Balance	4-37
4-4-1. Calibration	4-37
4-4-2. Service Adjustment	4-37
4-4-3. Adjustment	4-38
4-5. AV Control Tab	4-39
4-6. Software Upgrade	4-45
4-6-1. How to Check the Software Version	4-45
4-6-2. How to Upgrade Software	4-46
4-7. The Dimension	4-48
4-7-1. UE32F6100AW	4-48
4-7-2. UE40F6100AW	4-49
4-7-3. UE46F6100AW	4-50
4-7-4. UE55F6100AW	4-51
5. Wiring Diagram	5-1
5-1. Wiring Diagram	5-1
5-2. Connector	5-2
5-3. Connector Functions	5-5
5-4. Cables	5-6
5-5. The types of module	5-7

1. Precautions

1-1. Safety Precautions

Follow these safety, servicing and ESD precautions to prevent damage and to protect against potential hazards such as electrical shock.

1-1-1. Warnings



For continued safety, do not attempt to modify the circuit board.
Disconnect the AC power and DC power jack before servicing.

1-1-2. Servicing the LED TV

1. When servicing the LED TV, Disconnect the AC line cord from the AC outlet.
2. It is essential that service technicians have an accurate voltage meter available at all times. Check the calibration of this meter periodically.

1-1-3. Fire and Shock Hazard

Before returning the monitor to the user, perform the following safety checks:

1. Inspect each lead dress to make certain that the leads are not pinched or that hardware is not lodged between the chassis and other metal parts in the monitor.
2. Inspect all protective devices such as nonmetallic control knobs, insulating materials, cabinet backs, adjustment and compartment covers or shields, isolation resistor/capacitor networks, mechanical insulators, etc.
3. Leakage Current Hot Check:

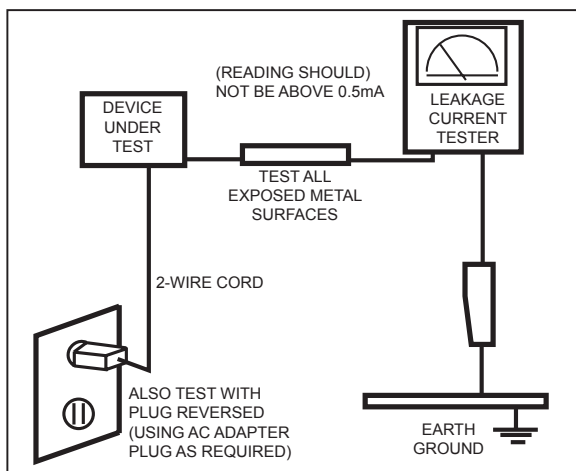

Do not use an isolation transformer during this test.

Use a leakage current tester or a metering system that complies with American National Standards Institute (ANSI C101.1, Leakage Current for Appliances), and Underwriters Laboratories (UL Publication UL1410, 59.7).

4. With the unit completely reassembled, plug the AC line cord directly into a 120V AC outlet. With the unit's AC switch first in the ON position and then OFF, measure the current between a known earth ground (metal water pipe, conduit, etc.) and all exposed metal parts, including: metal cabinets, screwheads and control shafts. The current measured should not exceed 0.5 milliamp. Reverse the power-plug prongs in the AC outlet and repeat the test.

1-1-4. Product Safety Notices

Some electrical and mechanical parts have special safety-related characteristics which are often not evident from visual inspection. The protection they give may not be obtained by replacing them with components rated for higher voltage, wattage, etc. Parts that have special safety characteristics are identified by  on schematics and parts lists. A substitute replacement that does not have the same safety characteristics as the recommended replacement part might create shock, fire and/or other hazards. Product safety is under review continuously and new instructions are issued whenever appropriate.

1-2. Servicing Precautions



An electrolytic capacitor installed with the wrong polarity might explode.



Before servicing units covered by this service manual, read and follow the Safety Precautions section of this manual.



If unforeseen circumstances create conflict between the following servicing precautions and any of the safety precautions, always follow the safety precautions.

1-2-1. General Servicing Precautions

1. Always unplug the unit's AC power cord from the AC power source and disconnect the DC Power Jack before attempting to: (a) remove or reinstall any component or assembly, (b) disconnect PCB plugs or connectors, (c) connect a test component in parallel with an electrolytic capacitor.
2. Some components are raised above the printed circuit board for safety. An insulation tube or tape is sometimes used. The internal wiring is sometimes clamped to prevent contact with thermally hot components. Reinstall all such elements to their original position.
3. After servicing, always check that the screws, components and wiring have been correctly reinstalled. Make sure that the area around the serviced part has not been damaged.
4. Check the insulation between the blades of the AC plug and accessible conductive parts (examples: metal panels, input terminals and earphone jacks).
5. Insulation Checking Procedure: Disconnect the power cord from the AC source and turn the power switch ON. Connect an insulation resistance meter (500 V) to the blades of the AC plug. The insulation resistance between each blade of the AC plug and accessible conductive parts (see above) should be greater than 1 megohm.
6. Always connect a test instrument's ground lead to the instrument chassis ground before connecting the positive lead; always remove the instrument's ground lead last.

1-3. Static Electricity Precautions

Some semiconductor (solid state) devices can be easily damaged by static electricity. Such components are commonly called Electrostatically Sensitive Devices (ESD). Examples of typical ESD are integrated circuits and some field-effect transistors. The following techniques will reduce the incidence of component damage caused by static electricity.

1. Immediately before handling any semiconductor components or assemblies, drain the electrostatic charge from your body by touching a known earth ground. Alternatively, wear a discharging wrist-strap device. To avoid a shock hazard, be sure to remove the wrist strap before applying power to the monitor.
2. After removing an ESD-equipped assembly, place it on a conductive surface such as aluminum foil to prevent accumulation of an electrostatic charge.
3. Do not use freon-propelled chemicals. These can generate electrical charges sufficient to damage ESDs.
4. Use only a grounded-tip soldering iron to solder or desolder ESDs.
5. Use only an anti-static solder removal device. Some solder removal devices not classified as "anti-static" can generate electrical charges sufficient to damage ESDs.
6. Do not remove a replacement ESD from its protective package until you are ready to install it. Most replacement ESDs are packaged with leads that are electrically shorted together by conductive foam, aluminum foil or other conductive materials.
7. Immediately before removing the protective material from the leads of a replacement ESD, touch the protective material to the chassis or circuit assembly into which the device will be installed.



Be sure no power is applied to the chassis or circuit and observe all other safety precautions.

8. Minimize body motions when handling unpackaged replacement ESDs. Motions such as brushing clothes together, or lifting your foot from a carpeted floor can generate enough static electricity to damage an ESD.

1-4. Installation Precautions

1. For safety reasons, more than a people are required for carrying the product.
2. Keep the power cord away from any heat emitting devices, as a melted covering may cause fire or electric shock.
3. Do not place the product in areas with poor ventilation such as a bookshelf or closet. The increased internal temperature may cause fire.
4. Bend the external antenna cable when connecting it to the product. This is a measure to protect it from being exposed to moisture. Otherwise, it may cause a fire or electric shock.
5. Make sure to turn the power off and unplug the power cord from the outlet before repositioning the product. Also check the antenna cable or the external connectors if they are fully unplugged. Damage to the cord may cause fire or electric shock.
6. Keep the antenna far away from any high-voltage cables and install it firmly. Contact with the highvoltage cable or the antenna falling over may cause fire or electric shock.
7. When installing the product, leave enough space (0.4m) between the product and the wall for ventilation purposes. A rise in temperature within the product may cause fire.

2. Product Specifications

2-1. Product Specifications

Item		UE**F6100AW
General Information	Product	LED
	Cabinet Basic Code	FP
	Series	6
	Series Name	LED F6100
	Country	EU
	Platform(TV)	Novatek NT13
Display	Inch	32" / 40" / 46" / 55"
	Resolution	1,920 x 1,080
	Ultra Clear Panel	No
	Lvds Format	JEIDA
	HV Flip	ON
Video	Picture Engine	3D HyperReal Engine
	Clear Motion Rate	480
	Dynamic Contrast Ratio	Mega Contrast
	Micro Dimming	Micro Dimming
	Precision Black (Local Dimming)	No
	Wide Color Enhancer (Plus)	Yes
	Auto Motion Plus 120/240Hz	120Hz
	Film Mode	Yes
	Brightness	300nits
	Contrast Ratio	5000:1
	Picture	3D-Effect, Film Mode, HDMI Black Level
	Detail Resolution	60Hz
	Response Time	8ms
	Viewing Angle (H/V)	178/178
Natural Mode Support	Yes	
Audio	Dolby	Dolby Digital Plus / Dolby Pulse
	SRS / DNSe+	SRS Theater Sound HD
	dts 2.0+ Digital Out / DTS Premium Audio	DTS Premium Audio
	3D Sound	Yes
	Sound Customizer	No
	Speaker Type	Down Firing + Full Range
	Sound Output (RMS)	10W x 2
	Woofer	No
	Sound Amp IC	TI TAS5745

2. Product specifications

Item		UE**F6100AW
Audio	Speaker Rated Power	10W x 2
	Woofer Speaker Rated Power	No
	Analog	2Ch
	Digital	Optical
SMART TV Functionality	Smart Hub	No
	Smart Guide	No
	Family Story	No
	Movie & TV Shows	No
	Fitness	No
	Apps	No
	Kids	No
	Social	No
	Music, Photos & Clip	No
	Samsung SMART View	No
	Your Video 2.0	No
	Social TV	No
	Samsung Sports Experience (SSE)	No
	Samsung Apps	No
	Smart Scene	No
	Skype™ on Samsung TV	No
	Web Browser	No
	AllShare Control	No
Recommendation Bar	No	
VESA Standard	Screw Size	M8
Smart Interaction	Camera Built-in	No
	Face Recognition	No
	Hand Gesture Recognition	No
	Voice Recognition (Embedded)	No
	Voice Recognition (Server)	No
	NLU (Natural Language Understanding)	No
	Camera App	No
	Samsung TV Apps supported	No
Feature	Samsung 3D	Yes
	3D Converter	Yes
	Dual View	N/A
	History	Yes
	Smart Phone Remote support	No
	Smart Evolution Support	No
	Extended PVR	Yes

	Item	UE**F6100AW
Feature	Time Shift	Yes
	Allshare Play	No
	ConnectShare™ (USB2.0)	Movie
	AllShare Cast	No
	RUI	NO
	RVU	N/A
	WiFi Direct	No
	Wireless LAN Built-in	No
	Wireless LAN Adaptor Support	No
	BT HID Built-in	Yes
	USB HID Support	Yes
	Network Speaker Support	N/A
	OSD Language	26 European Languages
	Samsung IR Blaster Support	No
	User Interface	Golden Bridge
	Digital Noise Filter	Yes
	Analog Noise Filter	N/A
	MHL	No
	Sound Share	Yes
	WiDi	N/A
	InstaPort S (HDMI quick switch)	No
	HDMI 1.4 3D Auto Setting	Yes
	HDMI 1.4 A/Return Ch. Support	Yes
	EPG	Yes
	Teletext (TTX)	Yes
	Triple Protector	N/A
	Miracast	Yes
	Anynet+ (HDMI-CEC)	Yes
	BD Wise Plus	Yes
	Auto Channel Search	Yes
	Auto Power Off	Yes
	Auto Volume Leveler	Yes
Caption (Subtitle)	Yes	
2 Tuner	No	
Clock&On/Off Timer	Yes	
Game Mode	Yes	
Picture-In-Picture	Yes	
Sleep Timer	Yes	

2. Product specifications

Item		UE**F6100AW
Feature	V-Chip	Yes
	Embedded POP	Yes
	Channel	Auto Store, Signal Level, Fine Tune
	Plug&Play	Yes
	Child Lock	Yes
	Soccer Mode	Yes
	Kids Lock	N/A
	Media Play(USB & DLNA)	Yes
	Bluetooth	Yes
	ACS	N/A
	IP Video Closed Caption	No
Additional Feature	Self Diagnosis	Yes
	Software Upgrade	Yes
	HD Connection Guide	Yes
	Contact Samsung	Yes
S/W	MCU Name	NT13
	OS	Linux
System	DTV Tuner	TC/T2C/TCS2/T2CS2
	Analog Tuner	Yes
	CI/ CI+	CI+ (1.3)
	Broadcast System	DVB-T/C/S2 (UK and Nordic : T2/C/S2), PAL, SECAM, NT4.4
	ATV Sound System	BK, DK, NICAM, MPEG1
	DTV Video System	DVB-T/C/S2 (UK and Nordic : T2/C/S2), PAL, SECAM, NT4.4
	DTV Sound System	Dolby
	Tuner Vendor & Model	TC - SEM DTOS40EIH035A T2C - SEM DNTS403EH105A TCS2 - SEM DNSS243IH105A T2CS2 - SEM DNSS243EH105A
Input & Output	HDMI	2
	Resolution	1920 x 1080
	DVI Port	Port1 Type
	PC Max Resolution	1920 x 1080 60 Hz
	USB	1
	Port 1 Type	Host
	Port 2 Type	No
	Port 3 Type	No
OS	Linux	



Item		UE**F6100AW
Input & Output	Component In (Y/Pb/Pr)	1
	Composite In (AV)	1 (Common Use for Component Y)
	Ethernet (LAN)	No
	Headphone	1
	Digital Audio Out (Optical)	1
	Audio Out (Mini Jack / LR)	No
	PC In (D-sub)	No
	PC Audio In (Mini Jack)	No
	DVI Audio In (Mini Jack)	1
	RF In (Terrestrial/Cable Input)	1
	RF In (Satelite Input)	1
	RS232C (AV CONTROL)	No
	SCART	1
	CI Slot	1
	Coaxial	No
	EX-Link	No
	Monitor Output	No
	DVI	
	Resolution	1920 x 1080i 60
	DVI Port	Port1 Type
PC Max Resolution	1920 x 1080 60 Hz	
Design	Design	ToC
	Bezel Type	NNB
	Slim Type	Slim 1
	Front Color	Black
	Light Effect (Deco)	No
	Stand Type	Quad
	Swivel (Left/Right)	Yes
	Emission	ToC
	Front Resin	PC+G/F
Design	Stand Packing Type	Bundle
ECO	Energy Efficiency Class	TBD
	Eco Mark	EU Ecolabel
	Eco Label	Yes
	Eco Sensor	Yes
Security	Kensington Lock	Yes
Accessory	3D Active Glasses (Included)	2 (SSG-5100GB)
	IR Blaster (Included)	No

2. Product specifications

Item		UE**F6100AW
Accessory	Wireless LAN Adaptor (Included)	No
	Network Speaker (Included)	No
	MOIP Camera (Included)	No
	Wireless Keyboard (Included)	No
	Remote Controller Model	TM1240
	Battery (for Remote Control)	Yes
	Mini Wall Mount Support	Yes
	Ultra Slim Wall Mount Support	No
	VESA Wall Mount Support	Yes
	Slim Gender Cable	No
	ANT-Cable	No
	Power Cable	Yes
	User Manual	Yes
	E-Manual	Yes
	Floor Stand Support	No

2-2. Detailed Specifications

2-2-1. Model Comparison

Model	UE**F6100AW		
Front View	 <p style="text-align: center;">* W : Width H : High D : Depth</p>		
Detail View			
Front Color	Black		
Dimensions (W x H x D)	32"	Set with Stand	743.8 x 508.7 x 191.7 mm
		Set without Stand	743.8 x 441.7 x 49.5 mm
	40"	Set with Stand	934 x 617.4 x 235 mm
		Set without Stand	934 x 548.6 x 49.6 mm
	46"	Set with Stand	1065.4 x 697.3 x 235 mm
		Set without Stand	1065.4 x 622.5 x 49.6 mm
	55"	Set with Stand	1256 x 798.6 x 235 mm
		Set without Stand	1256 x 729.3 x 19.2 mm
Weight	32"	Set with Stand	5.8 kg
		Set without Stand	5.1 kg
	40"	Set with Stand	10.4 kg
		Set without Stand	8.7 kg
	46"	Set with Stand	13.1 kg
		Set without Stand	11.5 kg
	55"	Set with Stand	18.3 kg
		Set without Stand	16.9 kg
Panel Type	Black		
Internal Memory	4 G		
DDR	1 G		
Feature	3D / USB HID / DLNA / Full Browsing / Miracast		

2-2-2. Feature & Specifications

Model	UE32F6100AW	
Feature		
<ul style="list-style-type: none"> • Digital-TV, RF, 2-HDMI, 1-Component,1-A/V, 1-USB2.0(Media Play) • PIP(in HDMI 1, 2 Component and Sub picture is available only in TV mode(DTV/ATV)) • CMR (Clear Motion Rate) : 200 • Dolby Digital Plus Pulse, DTS Premium Sound 5.1, DTS Studio Sound 		
Specifications		
Item	Description	
LCD Panel	32 inch FHD 120 Hz	
Input Signal Frequency	Horizontal : 31~80 kHz Vertical : 56 ~ 75 Hz	
Input Sync Signal	H/V Separate, TTL, P. or N.	
Display Colors	1.07 B	
Maximum Resolution	Horizontal : 1920 Pixels Vertical : 1080 Pixels	
Input Signal	Analog 0.7 Vp-p \pm 5% positive at 75 Ω , internally terminated	
Maximum Pixel Clock Rate	138 MHz	
Active Display (H x V)* * Horizontal x Vertical	698.4 (H) X 392.85 (V) mm	
AC Power Voltage & Frequency	AC220-240 V ~ 50/60 Hz	
Power Consumption	92 W (Under 0.3 W, Stand by)	
TV System	Tuning	Frequency Synthesize (Refer to detailed Frequency Table)
	System	DVB-T/C/S2 (UK and Nordic : T2/C/S2), PAL, SECAM, NT4.4
	Sound	BK, DK, NICAM, MPEG1, Dolby Digital +
Environmental Considerations	Operating Temperature : 50°F ~ 104°F (10°C ~ 40°C) Operating Humidity : 10% ~ 80%, non-condensing Storage Temperature : -13°F ~ 113°F (-25°C ~ 45°C) Storage Humidity : 5% ~ 95%, non-condensing	
Audio Specifications	MAX Internal Audio Output Power : Each 10 W (Left/Right) Equalizer : 5 Band Output Frequency : RF : 20 Hz ~ 15.4 kHz AV/Componet/HDMI : 20 Hz ~ 20 kHz	



Model	UE40F6100AW	
Feature		
<ul style="list-style-type: none"> • Digital-TV, RF, 2-HDMI, 1-Component,1-A/V, 1-USB2.0(Media Play) • PIP(in HDMI 1, 2 Component and Sub picture is available only in TV mode(DTV/ATV)) • CMR (Clear Motion Rate) : 200 • Dolby Digital Plus Pulse, DTS Premium Sound 5.1, DTS Studio Sound 		
Specifications		
Item	Description	
LCD Panel	40 inch FHD 120 Hz	
Input Signal Frequency	Horizontal : 31~80 kHz Vertical : 56 ~ 75 Hz	
Input Sync Signal	H/V Separate, TTL, P. or N.	
Display Colors	1.07 B	
Maximum Resolution	Horizontal : 1920 Pixels Vertical : 1080 Pixels	
Input Signal	Analog 0.7 Vp-p \pm 5% positive at 75 Ω , internally terminated	
Maximum Pixel Clock Rate	138 MHz	
Active Display (H x V)* * Horizontal x Vertical	885.6 H x 498.15 V mm	
AC Power Voltage & Frequency	AC220-240 V ~ 50/60 Hz	
Power Consumption	122 W (Under 0.3 W, Stand by)	
TV System	Tunning	Frequency Synthesize (Refer to detailed Frequency Table)
	System	DVB-T/C/S2 (UK and Nordic : T2/C/S2), PAL, SECAM, NT4.4
	Sound	BK, DK, NICAM, MPEG1, Dolby Digital +
Environmental Considerations	Operating Temperature : 50°F ~ 104°F (10°C ~ 40°C) Operating Humidity : 10% ~ 80%, non-condensing Storage Temperature : -13°F ~ 113°F (-25°C ~ 45°C) Storage Humidity : 5% ~ 95%, non-condensing	
Audio Specifications	MAX Internal Audio Output Power : Each 10 W (Left/Right) Equalizer : 5 Band Output Frequency : RF : 20 Hz ~ 15.4 kHz AV/Componet/HDMI : 20 Hz ~ 20 kHz	

2. Product specifications

Model	UE46F6100AW	
Feature		
<ul style="list-style-type: none"> • Digital-TV, RF, 2-HDMI, 1-Component,1-A/V, 1-USB2.0(Media Play) • PIP(in HDMI 1, 2 Component and Sub picture is available only in TV mode(DTV/ATV)) • CMR (Clear Motion Rate) : 200 • Dolby Digital Plus Pulse, DTS Premium Sound 5.1, DTS Studio Sound 		
Specifications		
Item	Description	
LCD Panel	46 inch FHD 120 Hz	
Input Signal Frequency	Horizontal : 31~80 kHz Vertical : 56 ~ 75 Hz	
Input Sync Signal	H/V Separate, TTL, P. or N.	
Display Colors	1.07 B	
Maximum Resolution	Horizontal : 1920 Pixels Vertical : 1080 Pixels	
Input Signal	Analog 0.7 Vp-p \pm 5% positive at 75 Ω , internally terminated	
Maximum Pixel Clock Rate	138 MHz	
Active Display (H x V)* * Horizontal x Vertical	1018.08 H x 572.67 V mm	
AC Power Voltage & Frequency	AC220-240 V ~ 50/60 Hz	
Power Consumption	128 W (Under 0.3 W, Stand by)	
TV System	Tunning	Frequency Synthesize (Refer to detailed Frequency Table)
	System	DVB-T/C/S2 (UK and Nordic : T2/C/S2), PAL, SECAM, NT4.4
	Sound	BK, DK, NICAM, MPEG1, Dolby Digital +
Environmental Considerations	Operating Temperature : 50°F ~ 104°F (10°C ~ 40°C) Operating Humidity : 10% ~ 80%, non-condensing Storage Temperature : -13°F ~ 113°F (-25°C ~ 45°C) Storage Humidity : 5% ~ 95%, non-condensing	
Audio Specifications	MAX Internal Audio Output Power : Each 10 W (Left/Right) Equalizer : 5 Band Output Frequency : RF : 20 Hz ~ 15.4 kHz AV/Componet/HDMI : 20 Hz ~ 20 kHz	

Model	UE55F6100AW	
Feature		
<ul style="list-style-type: none"> • Digital-TV, RF, 2-HDMI, 1-Component,1-A/V, 1-USB2.0(Media Play) • PIP(in HDMI 1, 2 Component and Sub picture is available only in TV mode(DTV/ATV)) • CMR (Clear Motion Rate) : 200 • Dolby Digital Plus Pulse, DTS Premium Sound 5.1, DTS Studio Sound 		
Specifications		
Item	Description	
LCD Panel	55 inch FHD 120 Hz	
Input Signal Frequency	Horizontal : 31~80 kHz Vertical : 56 ~ 75 Hz	
Input Sync Signal	H/V Separate, TTL, P. or N.	
Display Colors	1.07 B	
Maximum Resolution	Horizontal : 1920 Pixels Vertical : 1080 Pixels	
Input Signal	Analog 0.7 Vp-p \pm 5% positive at 75 Ω , internally terminated	
Maximum Pixel Clock Rate	138 MHz	
Active Display (H x V)* * Horizontal x Vertical	1209.6 (H) X 680.4 (V) mm	
AC Power Voltage & Frequency	AC220-240 V ~ 50/60 Hz	
Power Consumption	128 W (Under 0.3 W, Stand by)	
TV System	Tunning	Frequency Synthesize (Refer to detailed Frequency Table)
	System	DVB-T/C/S2 (UK and Nordic : T2/C/S2), PAL, SECAM, NT4.4
	Sound	BK, DK, NICAM, MPEG1, Dolby Digital +
Environmental Considerations	Operating Temperature : 50°F ~ 104°F (10°C ~ 40°C) Operating Humidity : 10% ~ 80%, non-condensing Storage Temperature : -13°F ~ 113°F (-25°C ~ 45°C) Storage Humidity : 5% ~ 95%, non-condensing	
Audio Specifications	MAX Internal Audio Output Power : Each 10 W (Left/Right) Equalizer : 5 Band Output Frequency : RF : 20 Hz ~ 15.4 kHz AV/Componet/HDMI : 20 Hz ~ 20 kHz	

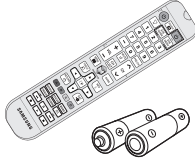
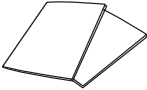
2-3. Accessories

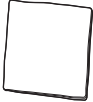
Product	Description	Code. No	Remark
	Remote Control Batteries (AAA x 2)	AA59-00743A (4301-000121)	
	Power Cord	3903-000849	
	Warranty Card / Regulatory Guide	BN68-03548J / BN68-04972A	
	User Manual	BN68-04906C	
	3D Active Glasses (for 40" models and above)	BN96-25614A	
	Holder-Ring	BN61-07295A	
	Holder-Wire Stand	BN61-08370A	
	Cloth-clean	BN63-01798B	

 **NOTE**

The part code for some accessories may differ depending on your region.

2-4. Viewing the Functions

2-4-1. Auto Motion Plus 120 Hz

■ Function Naming

- 120 Hz FRC + MJC : Auto Motion Plus 120 Hz

■ Detail Specifications

Function (OSD)	120 Hz FRC	Judder reduction (only 24p source)	Blur reduction
Off	Off (repeat)	Off	Off
Clear	ON (interpolation)	Off	High
Standard	ON (interpolation)	Medium	Medium
Smooth	ON (interpolation)	High	High
Custom	Level variable (0~10)		
Demo	Demo (Standard / Off)		

■ 120Hz Motion Enhancement



Off



Low / Medium / High



Demo

2-4-2. Supported Formats

■ Supported Subtitle Formats

Exterminal

Name	File Extension
MPEG-4 Timed text	Timed text .txt
SAMI	.smi
SubRip	.srt
SubViewer	.sub
Micro DVD	.sub or .txt
SubStation Alpha	.ssa
Advanced SubStation Alpha	.ass
Powerdivx	.psb

Internal

Name	File Extension
Xsub	AVI
SubStation Alpha	MKV
Advanced SubStation Alpha	MKV
SubRip	MKV
MPEG-4 Timed text	MP4

■ Supported Music File Formats

File Extension	Type	Codec	Comments
*.mp3	MPEG	MPEG1 Audio Layer 3	
*.m4a	MPEG4	AAC	
*.mpa			
*.aac			
*.flac	FLAC	FLAC	Supports up to 2 channel
*.ogg	OGG	Vorbis	Supports up to 2 channel
*.wma	WMA	WMA	WMA 10 Pro supports up to 5.1 channel. WMA lossless audio is not supported. Supports up to M2 profile (except LBR mode)
*.wav	wav	wav	
*.mid *.midi	midi	midi	type 0, type 1 are supported.
*.ape	ape	ape	

■ Supported Video Formats

File Extension	Container	Video Codec	Resolution	Frame rate (fps)	Bit rate (Mbps)	Audio Codec		
*.avi *.mkv *.asf *.wmv *.mp4 *.3gp *.vro *.mpg *.mpeg *.ts *.tp *.trp *.mov *.flv *.vob *.svi *.m2ts *.mts	AVI MKV ASF MP4 3GP MOV FLV VRO VOB PS TS SVAF	Divx 3.11 / 4 / 5 / 6	1920 x 1080	6~30	30	AC3 LPCM ADPCM(IMA, MS) AAC HE-AAC WMA DD+ MPEG(MP3) G.711(A-Law, μ -Law)		
MPEG4 SP/ASP								
H.264 BP/MP/HP								
			Motion JPEG		640 x 480		8	
			Microsoft MPEG-4 v3		1280 x 720			
			Window Media Video v7,v8		1920x1080		30	
			Window Media Video v9					
			MPEG2					
			MPEG1					
*.divx			MVC		640 x 480		24/25/30	60
			VP6				6~30	4
*.webm	WebM	VP8	1920 x1080		20	Vorbis		

■ Other Restrictions

Codecs may not function properly if there is a problem with the content data. Video content does not play or does not play correctly if there is an error in the content or container. "Sound or video may not work if they have standard bit rates/ frame rates above the TV's compatibility ratings." If the Index Table is wrong, the Seek (Jump) function does not work. "When playing video over a network connection, the video may not play smoothly because of data transmission speeds." Some USB/digital camera devices may not be compatible with the player.

■ Video Decoders

- Supports up to H.264, Level 4.1 (does not support FMO/ASO/RS)
- VC1 AP L4 is not supported.
- All video codecs excluding WMV v7, v8, MSMPEG4 v3, MVC, and VP6:
 - Below 1280 x 720: 60 frame max
 - Above 1280 x 720: 30 frame max
- GMC is not supported.
- Supports SVAF top/bottom and left/right only.
- Supports Blu-ray/DVD MVC specs only.

■ Audio Decoders

- WMA 10 Pro supports up to 5.1 channels. Supports up to M2 profile. (Excluding M0 LBR mode)
- WMA lossless audio is not supported.
- Vorbis is supported for up to 2 channels.
- DD+ is supported for up to 5.1 channels.

2-4-3. 3D Display

■ What is 3D Display?

This mode is to enable users to view images on the TV/Monitor in 3D by receiving the video signal in 3D format from sources such as 3D games and titles. The human brain constructs a 3 dimensional image from the two images entering both eyes. The depth of a 3 dimensional images is determined by the horizontal difference between the images from both the left and right eyes. 3D is displayed two images alternately on screen equivalent to left and right at TV, and embodied by doing to see each relevant image in left eye and right eye through shutter glasses.

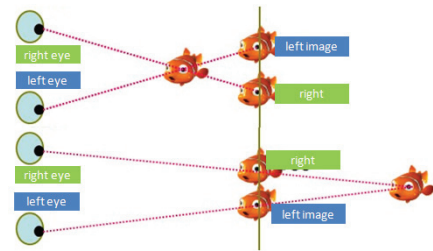

■ 3D Function of Model Series

LCD / LED / PDP TV		LED	
Items	Sub Items	120 Hz	
	Platform (Main)	X12	
	Platform (FRC / Formatter)	Fox-FT1 (SDC) Fox-FT2 (AUO / CMI) Echo-Fs (Sharp 3D) NT7231 2 (Sharp 2D)	
3D Feature	2D → 3D Conversion	O	
	3D → 2D	O	
	3D Perspective	O	
	3D Depth	O	
	Auto View (Auto Format Detection)	X	
	3D Optimize	O	
FRC Feature	Auto Motion Plus	O	
3D Input Format	ATV / AV, PC	2D → 3D	O
	Component	2D → 3D	O
		SS, TB	O
	HDMI	2D → 3D	O
		SS, TB	O
		FP 1080P 24 / 25 / 30 FP 720P 50 / 60 FP 1080i 50 / 60	O
		HDMI (PC / DVI)	LL, VS, Check ker BD, FS
	HDMI (PC / DVI)	2D → 3D	O
		SS, TB	O
		MPO	O
		SVAF IES (SS, BT)	O
		MVC 1080P 24 / 25 / 30 MVC 720P 50 / 60 MVC 1080i 50 / 60 MVC 720P 24 / 25 / 30	O
		DTV	2D → 3D
	SS, TB		O
	DVB_Phase1 (SS, BT)		O
	ATSC_KR30		O

■ Supported 3D Resolutions

These specifications apply to a display ratio of 16:9 only.

- 3D Format: L/R, T/B

Resolution	Frequency (Hz)
1280 x 720p	59.94 / 60
1920 x 1080i	59.94 / 60
1920 x 1080p	23.98 / 24 / 29.97 / 30 / 59.94 / 60

- 3D Format: Frame Packing

Resolution	Frequency (Hz)
1280 x 720p	59.94 / 60
1920 x 1080i	59.94 / 60
1920 x 1080p	23.98 / 24 / 29.97 / 30

- Component



Resolution	Frequency (Hz)
1280 x 720p	59.94 / 60
1920 x 1080i	59.94 / 60
1920 x 1080p	23.98 / 24 / 29.97 / 30 / 59.94 / 60

- Digital Channel

Resolution	Frequency (Hz)
1280 x 720p	59.94 / 60
1920 x 1080i	59.94 / 60

■ 3D Format Test

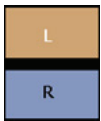
3D Format : There are several 3D formats existing on how to merge Left and Right images.

Format	Input images	Test Method
Frame Packin (HDMI 1.4)		Able to test only by HDMI 1.4 BD Player or MSPG-4600MT(Master Device)
Top & Bottom		Using Format_test.bmp <ul style="list-style-type: none"> • Check in the PC(HDMI) source. PC resolution and format resolution must be same • Wearing 3D glass, left eye sees only 'L' letter, right eye sees only 'R' letter (close your eyes one by one)
Side by Side		Using Format_test.bmp <ul style="list-style-type: none"> • Check in the PC(HDMI) source. PC resolution and format resolution must be same • Wearing 3D glass, left eye sees only 'L' letter, right eye sees only 'R' letter (close your eyes one by one)
2D → 3D		Check in the normal 2D source. Check not in the test pattern but in the actual video. <ul style="list-style-type: none"> • Left/Right black region will grow more and more as the depth goes higher.

3. Disassembly and Reassembly

This section of the service manual describes the disassembly and reassembly procedures for the LED TV.



This LED TV contains electrostatically sensitive devices. Use caution when handling these components.



3-1. Disassembly and Reassembly





1. Disconnect the LED TV from the power source before disassembly.
2. Follow these directions carefully; never use metal instruments to pry apart the cabinet.
3. If there is no additional coment, it is same for all inches.

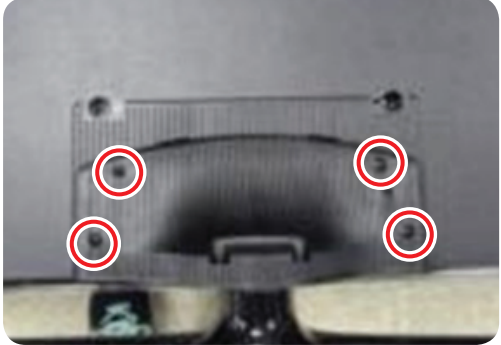

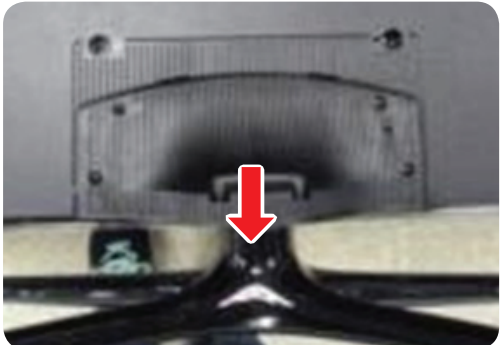

3-1-1. LED TV

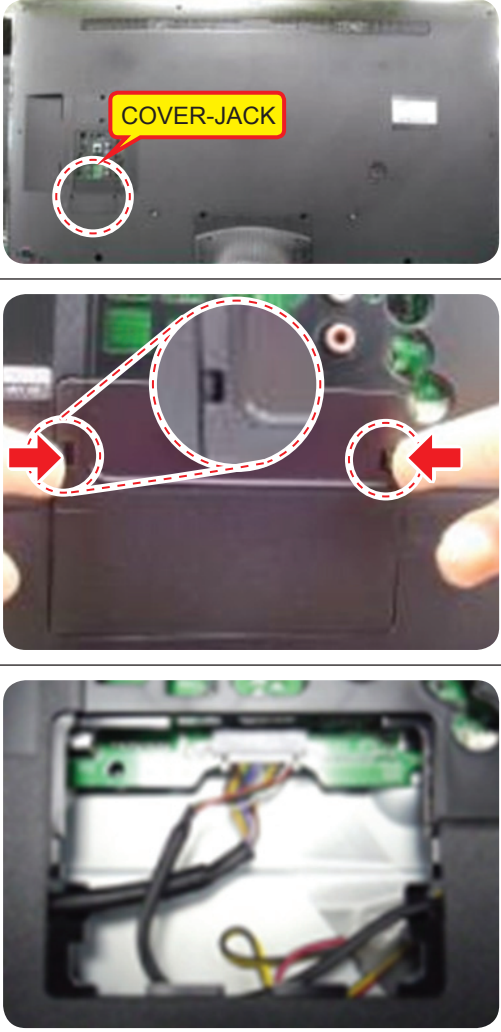
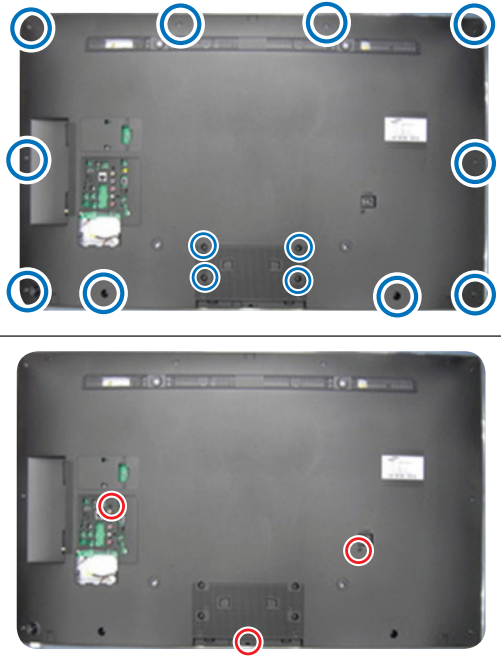
■ 32 / 40 / 46 Inches



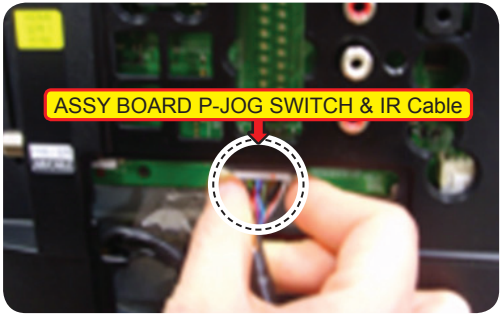

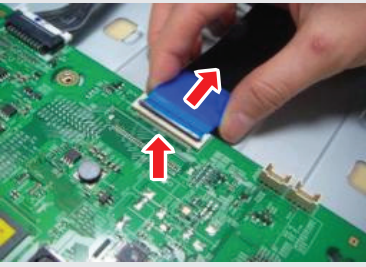
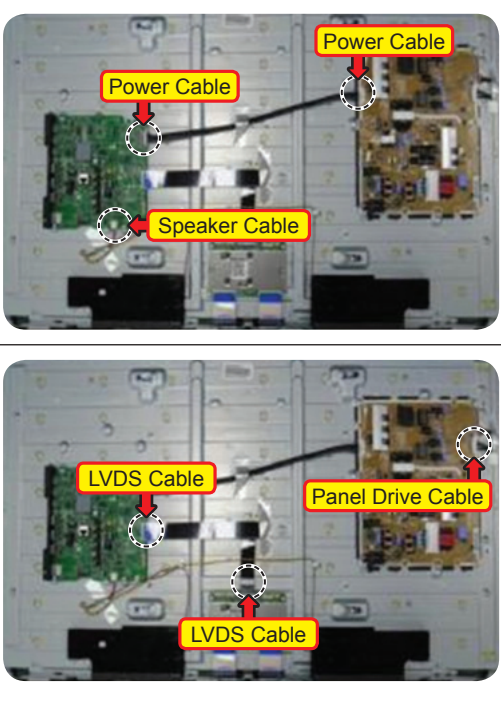
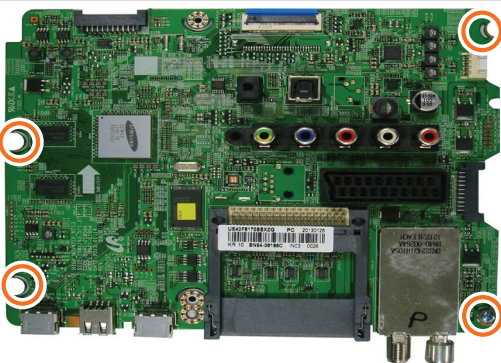
Description	Picture Description	Screws
<p>1 Place TV face down on cushioned table.</p>		
<p>2 Remove 4 screws from the ASSY GUIDE P-STAND.</p>		<div style="border: 1px solid black; padding: 5px; width: fit-content; margin-bottom: 10px;"> <p>Torque : 9~11Kgf.cm. 128~156psi</p> </div>  <p>6003-001782 SCREW-MACHINE M4.0, L12.0 BLK</p>
<p>3 Remove STAND.</p>		

3. Disassembly and Reassemble

Description	Picture Description	Screws
<p>4 Remove the COVER-JACK after push the locking in both sides.</p>		
<p>5 Remove screws of ASSY COVER P-MIDDLE, REAR.</p> <ul style="list-style-type: none"> • 32 inch : 9 EA • 40 inch : 14 EA • 46 inch : 14 EA <ul style="list-style-type: none"> • 32 inch : 2 EA • 40 inch : 2 EA • 46 inch : 3 EA 		<div style="display: flex; flex-direction: column; align-items: center;"> <div style="display: flex; align-items: center; margin-bottom: 10px;">  <div style="margin-left: 10px;"> <p style="font-size: 8px; background-color: yellow; padding: 2px;">Torque : 7~8Kgf.cm. 100~113psi</p> </div> </div> <div style="text-align: center;"> <p style="font-size: 10px; margin: 0;">6001-002755 SCREW-MACHINE M3.0, L6.0 BLK</p> </div> <div style="display: flex; align-items: center; margin-top: 10px;">  <div style="margin-left: 10px;"> <p style="font-size: 8px; background-color: yellow; padding: 2px;">Torque : 9~11Kgf.cm. 128~156psi</p> </div> </div> <div style="text-align: center;"> <p style="font-size: 10px; margin: 0;">6003-001782 SCREW-MACHINE M4.0, L12.0 BLK</p> </div> </div>

Description	Picture Description	Screws
<p>6 Disconnect the ASSY BOARD P-JOG SWITCH & IR Cable.</p> <p> NOTE First remove the cable before you remove the ASSY COVER P-MIDDLE, REAR.</p>		
<p>7 Remove the ASSY COVER P-MIDDLE, REAR.</p>		
<p>8 Remove the Power Cables and Speaker Cables. Remove the LVDS Cable and Panel Drive Cable.</p> <p> NOTE Applied to Double locking.</p> <ol style="list-style-type: none"> 1. Flip up the locking tab on top of the connector. 2. Squeeze the edge of the connector to release the second tab lock and gently pull the connector away. 		
<p>9 Remove the screws of ASSY PCB MAIN.</p>		<p>Torque : 7~8Kgf.cm. 100~113psi</p>  <p>6001-002756 SCREW-MACHINE M3.0, L6.0 WHT</p>

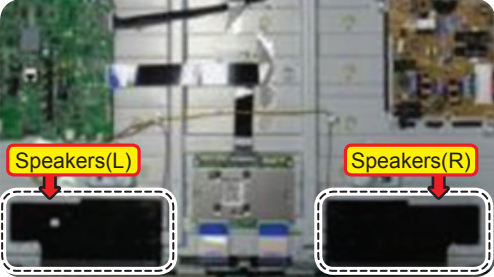
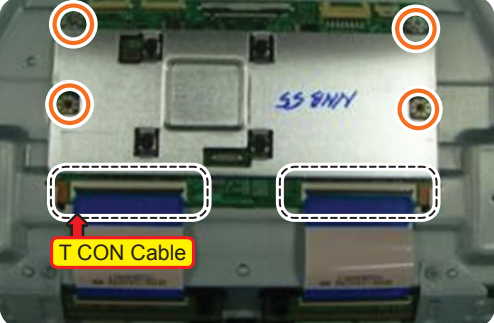
3. Disassembly and Reassemble







Description	Picture Description	Screws
<p>10 Remove the screws of DC VSS-LED TV PD BD.</p>		<p>Torque : 7~8Kgf.cm. 100~113psi</p>  <p>6001-002756 SCREW-MACHINE M3.0, L6.0 WHT</p>
<p>11 Remove the ASSY SPEAKER (L/R).</p>		
<p>12 Remove the 4 screws of ASSY T CON and unlock the locking of T CON Cable.</p>		<p>Torque : 7~8Kgf.cm. 100~113psi</p>  <p>6001-002756 SCREW-MACHINE M3.0, L6.0 WHT</p>
<p>13 Completed disassembly.</p> <ul style="list-style-type: none"> Panel. 		



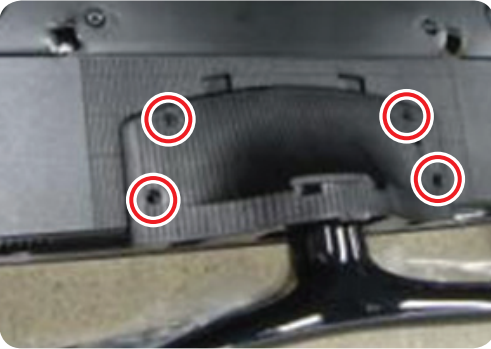



NOTE



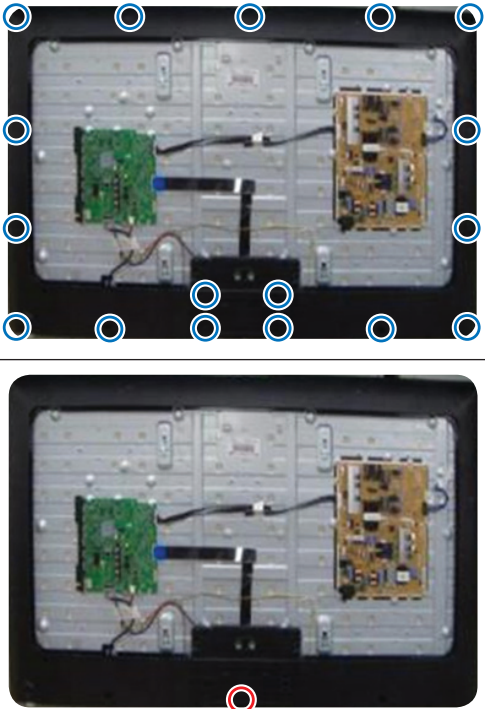

Reassembly procedures are in the reverse order of disassembly procedures.

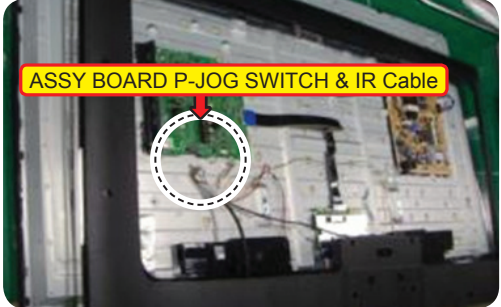
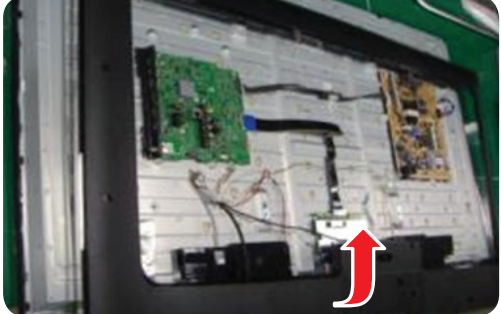
■ 55 Inches

Description	Picture Description	Screws
<p>1 Place TV face down on cushioned table.</p>		
<p>2 Remove 4 screws from the ASSY GUIDE P-STAND.</p>		<p>Torque : 9~11Kgf.cm. 128~156psi</p>  <p>6003-001782 SCREW-MACHINE M4.0, L12.0 BLK</p>
<p>3 Remove STAND.</p>		
<p>4 Remove screws of ASSY COVER P-REAR.</p> <ul style="list-style-type: none"> • 55 inch : 4 EA <ul style="list-style-type: none"> • 55 inch : 4 EA 	 	<p>Torque : 7~8Kgf.cm. 100~113psi</p>  <p>6001-002755 SCREW-MACHINE M3.0, L6.0 BLK</p> <p>Torque : 9~11Kgf.cm. 128~156psi</p>  <p>6003-001782 SCREW-MACHINE M4.0, L12.0 BLK</p>

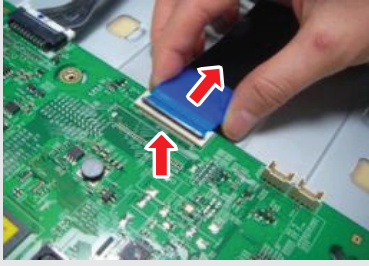
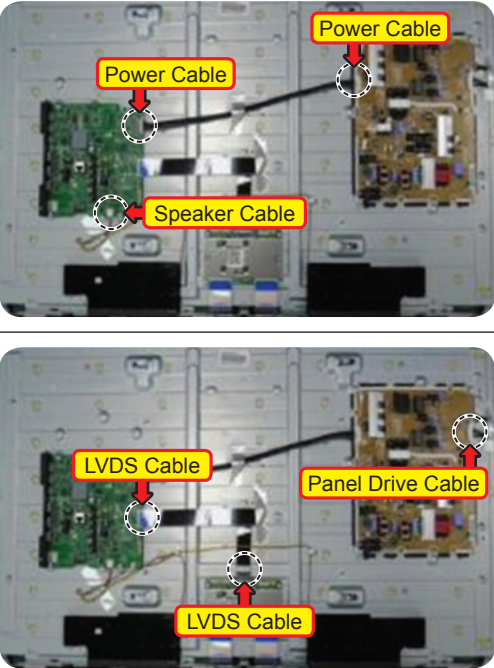
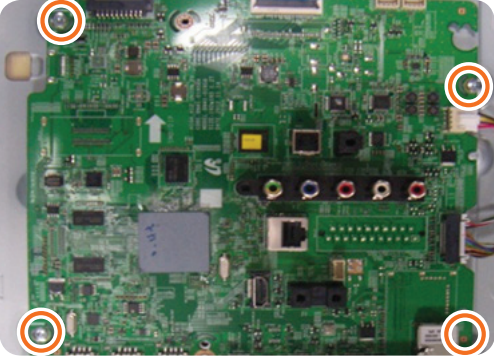
3. Disassembly and Reassemble

Description	Picture Description	Screws
<p>5 Remove 17 screws of ASSY COVER P-MIDDLE.</p> <p>Remove 1 screws of ASSY COVER P-MIDDLE.</p> <p>! CAUTION Be careful when you lift up the ASSY COVER P-MIDDLE, It's really sharp.</p>		<p>Torque : 7~8Kgf.cm. 100~113psi</p>  <p>6001-002755 SCREW-MACHINE M3.0, L6.0 BLK</p> <p>Torque : 9~11Kgf.cm. 128~156psi</p>  <p>6003-001782 SCREW-MACHINE M4.0, L12.0 BLK</p>
<p>6 Disconnect the ASSY BOARD P-JOG SWITCH & IR Cable.</p> <p>NOTE First remove the cable before you remove the ASSY COVER P-MIDDLE.</p>		
<p>7 Lift up the ASSY COVER P-MIDDLE.</p>		
<p>8 Remove the ASSY COVER P-MIDDLE.</p>		

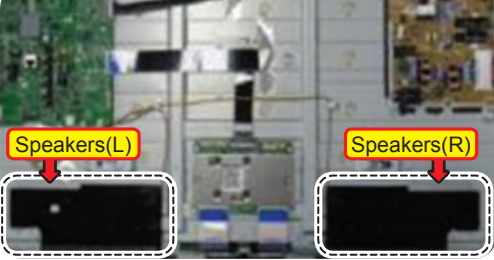
Description	Picture Description	Screws
<p>9 Remove the Power Cables and Speaker Cables. Remove the LVDS Cable and Panel Drive Cable.</p> <p> NOTE Applied to Double locking.</p> <ol style="list-style-type: none"> 1. Flip up the locking tab on top of the connector. 2. Squeeze the edge of the connector to release the second tab lock and gently pull the connector away. 		
<p>10 Remove the screws of ASSY PCB MAIN.</p>		 <p>6001-002756 SCREW-MACHINE M3.0, L6.0 WHT</p>
<p>11 Remove the screws of DC VSS-LED TV PD BD.</p>		 <p>6001-002756 SCREW-MACHINE M3.0, L6.0 WHT</p>
<p>12 Remove the ASSY SPEAKER (L/R).</p>		

3. Disassembly and Reassemble

Description	Picture Description	Screws
<p>13 Remove the 4 screws of ASSY T CON and unlock the locking of T CON Cable.</p>		<p>Torque : 7~8Kgf.cm. 100~113psi</p>  <p>6001-002756 SCREW-MACHINE M3.0, L6.0 WHT</p>
<p>14 Completed disassembly.</p> <ul style="list-style-type: none"> Panel. ASSY COVER P-MIDDLE. 		



 **NOTE**

Reassembly procedures are in the reverse order of disassembly procedures.

Screw Size

Code No.	COLOR	A (mm)	B (mm)	C (mm)	D (mm)	E (mm)	Screw Image
6003-001782	BLACK	7.80~8.20	1.85~1.95	3.81~3.91	11.4~12.0	-	<p>CROSS #2(3.56) RECESS B 8.0R * C 0.6 ± 0.1 M4.0 x 1.8 TAPPING Δ B-TYPE</p>
6001-002755	BLACK	7.1~7.5	1.9~2.0	2.98~3.02	5.7~6.0	4.4~5.4	<p>CROSS #2(3.08) 母寸 Punch D:7.5 M3 x 0.5 PITCH SCALOCK TRAP 드로</p>
6001-002756	WHITE	5.6~6.0	1.15~1.25	2.92~2.98	3.7~4.0	4.4~5.4	<p>CROSS #2(★M3.0F) RECESS M3 x 0.5 PITCH SCALOCK BWI TRAP 드로</p>

3-1-2. ASSY BOARD P-RF-MODULE

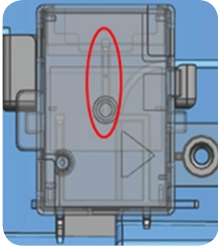
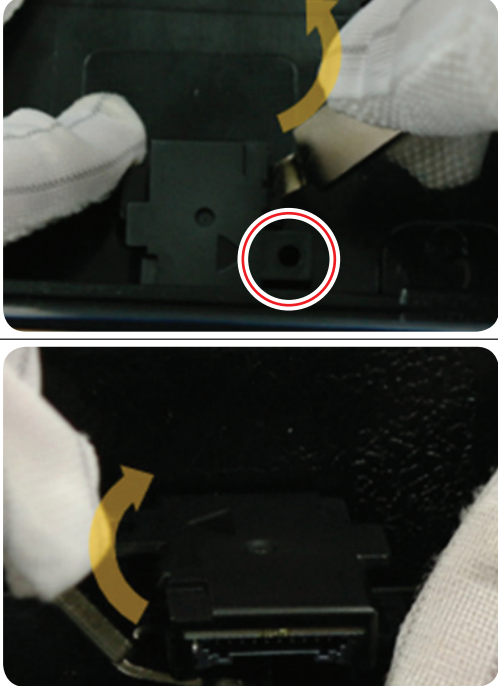
Description	Picture Description	Refer
<p>1 Preparation : BN81-00001A (Registered in Jig material)</p> 		
<p>2 Twist the jig after inserting ASSY BOARD P-RF-MODULE(B/T module) and ASSY COVER P-MIDDLE,REAR.</p>		

 **NOTE**

Reassembly procedures are in the reverse order of disassembly procedures.

1. Exploded View & Part List

Exploded View

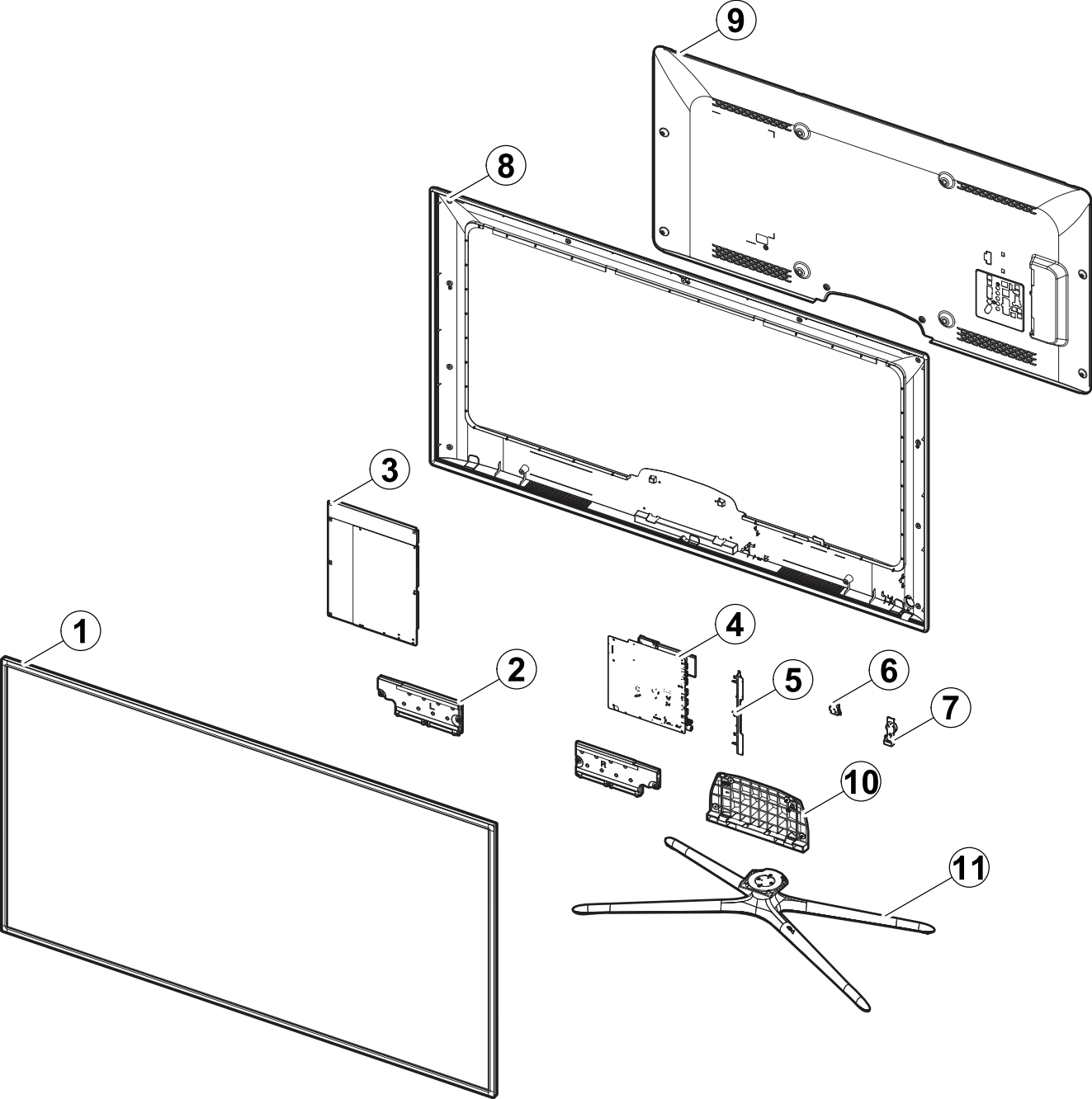

Parts List

No.	Lvl.	Loc.	Material Code	Description & Specification	SNA	Qty.
1	2	PANEL	BN95-00895A	PRODUCT LCD-AMLCD; LSF550HJ02,CY-HF550CSL	SA	1
2	2	SP01A	BN96-25565C	ASSY SPEAKER P; 6ohm,10W,Enclosure_5300	SA	1
3	2	P001A	BN44-00625A	DC VSS-LED TV PD BD; L55X1Q_DSM,PSLF181X0	SA	1
4	2	M0014	BN94-06165Z	ASSY PCB MAIN; F6100,55,XC	SA	1
5	3		BN61-09059A	HOLDER-SIDE AV; UF6100,HIPS,BK0020,HB,EO/	SNA	1
6	2	BT	BN96-25376A	ASSY BOARD P-RF-MODULE; Bluetooth Module,	SA	1
7	3		BN96-26401P	ASSY BOARD P-JOG SWITCH & IR; UE55F6100,F	SA	1
8	2	M001A	BN96-25528C	ASSY COVER P-MIDDLE; UF6100/6170 55,EUROP	SA	1
9	2	R001A	BN96-25539C	ASSY COVER P-REAR; UF6100 55,EUROPE/CIS,P	SA	1
10	2	SG01A	BN96-25543A	ASSY GUIDE P-STAND; UF6100 40,QUAD	SA	1
11	2	SB04A	BN96-25365A	ASSY STAND P-BASE; UF5500,50,PC+ABS,V0,BK	SA	1

2. Electrical Parts List

Level	Loc.	Part Code	Description & Specification	Qty.	SA/SNA
			UE55F6100AWXXN (TS01)		
1	R001A	BN90-04140N	ASSY COVER REAR;UF6K	1	SNA
.2	R001A	BN96-25539C	ASSY COVER P-REAR;UF6100 55,EUROPE/CIS,P	1	SA
..3		BN60-00162Z	SPACER-FOAM;FOAM,50000mm,DARK GRAY,0.35T	1	SNA
..3		BN63-08448B	GASKET-EMI;51 U/SLIM,Conductive Fabric,1	4	SNA
..3		BN63-09121D	SHEET-INSULATOR SMPS;UE6500,40/46/55,PP,	1	SNA
..3	R001	BN63-10184A	COVER-REAR;F6100 55",PCM,T0.4	1	SNA
..3	T0071	BN64-02263D	INLAY-TERMINAL;UF6100, 55,EO/CIS,PS SHEE	1	SNA
..3		BN68-05188G	LABEL-TERMINAL SIDE;UF6100,EU/CIS,PET,T0	1	SNA
1		BN90-04369F	ASSY COVER MIDDLE;UF6K 55	1	SNA
.2		6001-002755	SCREW-MACHINE;BH,+,M3,L6,ZPC(BLK),SWRCH1	17	SA
.2	SCREW	6003-001782	SCREW-TAPTYPE;BH,+,B,M4,L12,ZPC(BLK),SWR	1	SA
.2	M001A	BN96-25528C	ASSY COVER P-MIDDLE;UF6100/6170 55,EUROP	1	SA
..3		0203-001598	TAPE-FILAMENT;#8915,0.15,12,55000,CLR	0	SNA
..3	SCREW	6003-000115	SCREW-TAPTYPE;BH,+,B,M3,L6,ZPC(BLK),SWRC	2	SNA
..3		BN63-08608B	COVER-SHEET;RhcM,PE Vinyl,T 0.04,80MM,20	4	SNA
..3	R002A	BN63-10191B	COVER-MIDDLE;F6100/6330 55,PC V2/PC+ABS	1	SNA
...4		0103-007268	RESIN-PC;TN-1045M,70784,TP0010,0.8, 3.0	600	SNA
...4		0103-009587	RESIN-PC ABS;NE-1010,431322,RD0071,1.5 V	1400	SNA
..3		BN63-10851A	SHEET-COVER;UF5000,PET,0.1,45,16,BLACK	2	SNA
..3		BN96-26401P	ASSY BOARD P-JOG SWITCH & IR;UE55F6100,F	1	SA
..4	EC13	BN39-01771C	LEAD CONNECTOR;UE55F6100,Cable Connector	1	SNA
..4	5WAY	BN96-26401A	ASSY BOARD P-JOG SWITCH & IR;UE32F5000,F	1	SNA
1	S001A	BN90-04383W	ASSY STAND;UF6500 46	1	SNA
.2	SB04A	BN96-25365A	ASSY STAND P-BASE;UF5500,50,PC+ABS,V0,BK	1	SA
..3		6002-001294	SCREW-TAPPING;BH,+,M4,L16,ZPC(BLK)	4	SA
..3	SCREW	6003-001425	SCREW-TAPTYPE;BH,+,B,M4,L25,ZPC(BLK),SWR	4	SNA
..3	SCREW	6003-001785	SCREW-TAPTYPE;FH,+,B,M4,L8,ZPC(BLK),SWRC	4	SA
..3	SCREW	6003-001832	SCREW-TAPTYPE;FH,+,B,M4,L30,ZPC(BLK),SWR	1	SNA
..3		BN61-07159C	HOLDER-SWIVEL, TOP;46/50/55 QUAD STAND,AC	1	SNA
..3		BN61-07739A	BRACKET-SWIVEL,BOTTOM;UD8000 46/55 QUAD,	1	SNA
..3		BN61-07745A	BRACKET-SWIVEL, TOP;UD8000 46"/55" QUAD,S	1	SNA
..3		BN61-08737A	HOLDER-SWIVEL,BOTTOM;46-55 SLIM QUAD STA	1	SNA
...4		0103-009825	RESIN-POM;TS-25A,Dark Gray,GY0199,HB	6	SNA
..3		BN61-08738A	HOLDER-STAND,NECK;46-55 SLIM QUAD STAND,	1	SNA
..3		BN61-08739A	BRACKET-STAND, TOP;46-55 SLIM QUAD STAND,	1	SNA
..3		BN61-08740A	BRACKET-STAND,BOTTOM;46-55 SLIM QUAD STA	1	SNA
..3		BN63-05135E	COVER-SHEET;4-LEG,RhcM PE Vinyl,T0.05,W6	2	SNA

Exploded Views and Parts List

Level	Loc.	Part Code	Description & Specification	Qty.	SA/SNA
...3		BN63-10161A	COVER-STAND,BASE;46-55 SLIM QUAD STAND,A	1	SNA
...3		BN63-10703D	COVER-STAND, TOP-FRONT;F5500,46,ABS+PC,-,	1	SNA
...3		BN63-10706D	COVER-STAND, TOP-REAR, LEFT;F5500,46,ABS+	1	SNA
...3		BN63-10709D	COVER-STAND, TOP-REAR, RIGHT;F5500,46,ABS+	1	SNA
...4		0103-005041	RESIN-PC;FR3200TV,901408,BK0008,1.2mm V-	55	SNA
...3		BN67-00385D	RUBBER-FOOT;RUBBER-FOOT,SILICONE,ROUND,1	4	SNA
.2	SG01A	BN96-25543A	ASSY GUIDE P-STAND;UF6100 40,QUAD	1	SA
...3	SG03	BN61-08823A	GUIDE-STAND;UF6100 55",PC+GF,G/F 20%	1	SNA
...4		0103-007285	RESIN-PC;MW32020GFU,K032202GFV,BK0007,V2	250	SNA
...4		BN68-00513D	LABEL-RESIN;resin,-,art paper,-,10,25,-,	1	SNA
...3	T0527	BN68-00513A	LABEL-E,PASS;ALL MODEL,YUPO(110G),50X15,	1	SNA
...3		BN69-08751A	WRAP VINYL-SHRINK;STAND,PLASTIC OTHERS,P	0	SNA
...3		BN96-18013E	ASSY ACCESSORY-SCREW;6003-001782,4EA,ALL	2	SNA
...4	SCREW	6003-001782	SCREW-TAPTYPE;BH,+ ,B,M4,L12,ZPC(BLK),SWR	8	SA
...4		BN69-08203E	PACKING-BAG-SCREW;LDPE,0.05,70,90,TRP,Vi	2	SNA
1		BN90-04578G	ASSY W/I;UF6K	1	SNA
.2		BN81-08159U	PART SET-MECH W/I;UF6M,U55FP*	1	SNA
.2		BN81-08159Z	PART SET-ELEC W/I;UF4* ~ UF8* ELEC	1	SNA
1		BN91-06930E	ASSY SHIELD;F6100, 55,EUROPE	1	SNA
.2		6001-003016	SCREW-MACHINE;PWH,+ ,M3.0,L5.0,ZPC(WHT),S	9	SA
.2		BN02-00102B	TAPE FILAMENT;UE7000,#893,0.15,25,50,WHI	0	SNA
.2	EC13	BN39-01475V	LEAD CONNECTOR;UN55F6100,Falt Connector,	1	SA
.2	EC14	BN39-01744A	LEAD CONNECTOR-LED WIRE HARNESS;DIRECT w	1	SA
.2	P001A	BN44-00625A	DC VSS-LED TV PD BD;L55X1Q_DSM,PSLF181X0	1	SA
.2	FL06	BN96-24278M	ASSY CABLE P-FFC;UE55F6170,FFC,472mm,51P	1	SA
.2	BT	BN96-25376A	ASSY BOARD P-RF-MODULE;Bluetooth Module,	1	SA
...3	AS BT	BN81-08545A	A/S-BT;Bluetooth Module SCREW	1	SNA
...3		BN97-07275A	ASSY MICOM-BLUETOOTH F/W;BN81-08385A	1	SNA
...4		BN81-08385A	AS-BLUETOOTH F/W;BLUETOOTH F/W	1	SNA
.2	SP01A	BN96-25565C	ASSY SPEAKER P;6ohm,10W,Enclosure_5300	1	SA
1		BN91-10240A	ASSY LCM-AMLCD;BN95-00895A	1	SNA
.2	PANEL	BN95-00895A	PRODUCT LCD-AMLCD;LSF550HJ02,CY-HF550CSL	1	SA
...3		6001-002757	SCREW-MACHINE;BH,+ ,M3,L4,ZPC(WHT),SWRCH1	6	SA
...3		BN02-00102B	TAPE FILAMENT;UE7000,#893,0.15,25,50,WHI	3	SNA
...3		BN63-07229H	COVER-SHEET;rose70",SILICONE,T0.052,W25m	1	SNA
...3	AS109	BN63-11085A	SHEET-SIDE;F6100,TAPE,0.125,25mm,130m,BL	3	SNA
...3		BN68-02471A	LABEL-STICKER;WW,Art Paper,80,40,AV	1	SNA
...3		BN90-04400A	ASSY MISC-BLU;Slim F-LED,6K 3D	1	SNA
...4		BN02-00152H	TAPE ETC-SHEET FIXING;Y13 Slim F-LED,PET	3	SNA
...4		BN61-09001A	LGP-DIFFUSESR PLATE;55inch SFLED Diffuse	1	SNA

Level	Loc.	Part Code	Description & Specification	Qty.	SA/SNA
...4		BN61-09304A	SUPPORT-PLATE;Y13 SLIM / VNB,PC,WHT + CL	16	SNA
...4		BN63-10451A	SHEET-REFLECTOR;UXJP175,SHEET*,0.175,123	1	SNA
...4		BN63-10916A	SHEET-DIFFUSER;CH273M_55inch_NNB,SHEET*,	1	SNA
...4		BN63-10917A	SHEET-DBEF;DBEF D2 400_55inch_NNB,SHEET*	1	SNA
...4		BN96-25103A	ASSY FRAME P-MOLD MIDDLE(U);Y13 F-LED SI	1	SNA
....5		BN60-00748N	SPACER-PANEL (UP);13 SF-LED 55,SILICON+T	2	SNA
....5		BN61-08723A	FRAME-MOLD MIDDLE(U);Y13 F-LED Slim 55",	1	SNA
...4		BN96-25114A	ASSY FRAME P-MOLD MIDDLE(D);Y13 F-LED SI	1	SNA
....5		BN60-00744A	SPACER-RUBBER;Y13 F-LED SLIM,SH-0140U+AT	1	SNA
....5		BN60-00748P	SPACER-PANEL (DOWN);13 SF-LED 55,SILICON	2	SNA
....5		BN61-08724A	FRAME-MOLD MIDDLE(D);Y13 F-LED Slim 55",	1	SNA
...4		BN96-25115A	ASSY FRAME P-MOLD MIDDLE(LR);Y13 F-LED S	2	SNA
....5		BN60-00748Q	SPACER-PANEL (LR);13 SF-LED 55,SILICON+T	2	SNA
....5		BN60-00748R	SPACER-PANEL (CORNER);13 SF-LED 55,SILIC	2	SNA
....5		BN61-08725A	FRAME-MOLD MIDDLE(LR);Y13 F-LED Slim 55"	2	SNA
...4		BN96-25291A	ASSY MISC P-CHASSIS BOTTOM;Y13 SF-LED 55	1	SNA
....5		6001-002757	SCREW-MACHINE;BH,+,M3,L4,ZPC(WHT),SWRCH1	1	SA
....5		6001-003005	SCREW-MACHINE;BH,+,M3,L6,ZPC(WHT),SWRCH1	4	SNA
....5		BN02-00040C	TAPE DOUBLE FACE-D-PLATE;F-LED ALL,MKT50	2	SNA
....5		BN02-00043D	TAPE ETC-SHEET FIXING;Y13 slim F-LED,PET	2	SNA
....5		BN61-08161A	HOLDER-LED-PCB;Direct-LED,PC,white	2	SNA
....6		0103-009493	RESIN-PC;LH-1070W,W92853,WT0107,V-2	2	SNA
....5		BN61-08815A	HOLDER-SOURCE PCB;SLIM-FLED,ABS+PC,BLK,V	4	SNA
....6		0103-005041	RESIN-PC;FR3200TV,901408,BK0008,1.2mm V-	6	SNA
....5		BN61-09049A	BRACKET-WALL MOUNT;Y13 ALL Model,SPCC,T1	4	SNA
....5		BN61-09101A	SUPPORT-SOURCE PCB;SF-LED,ABS+PC,V0,GRAY	8	SNA
....6		0103-009930	RESIN-PC ABS;NH-1017SG,GRAY,GY0275,V0	12	SNA
....5		BN62-00338E	INSULATION CABI-PD BOARD;Y13 SF-LED 39"~	1	SNA
....5	CC02	BN64-02202A	CHASSIS-BOTTOM;Y13 F-LED 55,EGI-SECC,T0.	1	SNA
....5		BN96-25338A	ASSY BOARD P-D-LED INTERFACE;55inch Slim	1	SNA
....5		GL63-00014A	SHIELD-EMI GASKET DTB-H390V/XEE;DTB-H390	2	SNA
...4		BN96-25312A	ASSY MISC P-LED BAR;55inch Slim Direct L	10	SNA
...4		BN96-25313A	ASSY MISC P-LED BAR;55inch Slim Direct L	10	SNA
..3	TCON	BN95-00864A	ASSY T CON;LSF550HJ02,55 FHD 120 NNB	1	SA
...4		BN62-00366A	HEAT SINK-PS;F6000,A1050,ANODIZING,80*61	1	SNA
...4		BN97-07277A	ASSY SMD;BN95-00864A	1	SNA
....5		0202-001899	SOLDER-CREAM;M705-GRN360-K2-VT,25-36um,S	2	SNA
....5	DS01A	0401-001192	DIODE-SWITCHING;MMBD7000LT1,100V,200mA,S	2	SA
....5		0403-001172	DIODE-ZENER;UDZ6.8B,6.65-6.93V,200MW,SOD	1	SNA
....5		0404-001640	DIODE-SCHOTTKY;SS1060HEWS,60V,1000mA,SOD	2	SA

Exploded Views and Parts List

Level	Loc.	Part Code	Description & Specification	Qty.	SA/SNA
....5		0404-001643	DIODE-SCHOTTKY;B360A,60V,3000mA,SMA,TP	1	SA
....5		0406-001317	DIODE-TVS;SMAJ14A,15.6/-/17.2V,400W,SMA	1	SNA
....5		0406-001324	DIODE-TVS;RClamp1502B,16.7/-/V,200W,SOT	1	SNA
....5		0406-001438	DIODE-TVS;SMCJ14A,15.6/-/17.2V,1500W,DO-	1	SA
....5		0406-001445	DIODE-TVS;RClamp7512N,2.7/2.8/2.9,300W,S	2	SA
....5		0406-001483	DIODE-TVS;ESD5B5.0ST1G,5,8V/- /7.8V,50W,	2	SA
....5		0406-001556	DIODE-TVS;NUP4114UCW1,6/-/V,180W,SC-88	3	SA
....5		0406-001578	DIODE-TVS;P4SMAJ40A,44.4,51.1,400W,SMA	1	SA
....5		0501-000465	TR-SMALL SIGNAL;MMBT3904,NPN,350mW,SOT-2	1	SA
....5		0502-001331	TR-POWER;NSS30100LT1G,PNP,310mW,SOT-23,T	2	SA
....5		0502-001345	TR-POWER;FCX491A,NPN,1000mW,SOT89,TR,900	4	SA
....5		0502-001346	TR-POWER;FCX591A,PNP,1000mW,SOT89,TR,30/	4	SA
....5		0505-002826	FET-SILICON;ZXMN6A07F,N,60V,1A,0.4ohm,0.	1	SNA
....5		0505-003224	FET-SILICON;AO6405,P,-30V,-5A,0.052ohm,2	1	SA
....5	EL02	0601-002037	LED;SMD(TOP VIEW),BLUE,1.6x0.8mm,465/470	3	SA
....5		0801-003292	IC-CMOS LOGIC;7WB66,Bus Switch,MAB08A,8P	1	SA
....5		1105-002227	IC-DDR3 SDRAM;K4B1G1646G-BCK0,DDR3 SDRAM	1	SA
....5		1201-003130	IC-OP AMP;iML2811SEC,TDFN-EP,TP,8P,3x3mm	1	SA
....5		1203-006130	IC-POSIFIXED REG.;S-1172B25-U5T1G,SOT-8	1	SA
....5		1203-006138	IC-POSIAJUST REG.;AP1117DGZ-13-89,TO-2	1	SA
....5		1203-007191	IC-DC/DC CONVERTER;SM4152LA,QFN,48P,7x7m	1	SNA
....5		1203-007447	IC-VOL. GENERATOR;RT6503GQW,QFN,48Z30,7x	1	SNA
....5		1203-007552	IC-DC/DC CONVERTER;TPS56921PWPR,HTSSOP,2	1	SA
....5		1204-003406	IC-VIDEO PROCESS;SDP1203,HSFCBGA,756Z30,	1	SA
....5	IS01	1209-002183	IC-SENSOR;S-5851AAA-M6T1U,SOT,6Z30,2.9x1	1	SA
....5		2007-000040	R-CHIP;150ohm,1%,1/10W,TP,1608	1	SNA
....5		2007-000043	R-CHIP;1Kohm,1%,1/10W,TP,1608	2	SA
....5		2007-000052	R-CHIP;10Kohm,1%,1/10W,TP,1608	4	SA
....5		2007-000060	R-CHIP;100Kohm,1%,1/10W,TP,1608	1	SNA
....5		2007-000063	R-CHIP;150Kohm,1%,1/10W,TP,1608	1	SA
....5		2007-000066	R-CHIP;20Kohm,1%,1/10W,TP,1608	3	SNA
....5		2007-000067	R-CHIP;15Kohm,1%,1/10W,TP,1608	3	SNA
....5		2007-000070	R-CHIP;0ohm,5%,1/10W,TP,1608	16	SA
....5		2007-000109	R-CHIP;1Mohm,5%,1/10W,TP,1608	1	SA
....5		2007-000138	R-CHIP;100ohm,5%,1/16W,TP,1005	11	SA
....5		2007-000140	R-CHIP;1Kohm,5%,1/16W,TP,1005	3	SNA
....5		2007-000141	R-CHIP;2.2Kohm,5%,1/16W,TP,1005	1	SNA
....5		2007-000143	R-CHIP;4.7Kohm,5%,1/16W,TP,1005	11	SNA
....5		2007-000148	R-CHIP;10Kohm,5%,1/16W,TP,1005	9	SA
....5		2007-000168	R-CHIP;470Kohm,5%,1/16W,TP,1005	1	SNA

Level	Loc.	Part Code	Description & Specification	Qty.	SA/SNA
....5		2007-000170	R-CHIP;1Mohm,5%,1/16W,TP,1005	1	SNA
....5		2007-000171	R-CHIP;0ohm,5%,1/16W,TP,1005	9	SNA
....5		2007-000219	R-CHIP;1.2Kohm,1%,1/10W,TP,1608	2	SA
....5		2007-000265	R-CHIP;1.8Kohm,1%,1/10W,TP,1608	1	SA
....5		2007-000336	R-CHIP;120Kohm,1%,1/10W,TP,1608	3	SA
....5		2007-000455	R-CHIP;18Kohm,1%,1/10W,TP,1608	1	SA
....5		2007-000491	R-CHIP;2.2Kohm,1%,1/10W,TP,1608	1	SA
....5		2007-000516	R-CHIP;2.7Kohm,1%,1/10W,TP,1608	3	SNA
....5		2007-000669	R-CHIP;2Kohm,1%,1/10W,TP,1608	2	SNA
....5		2007-000726	R-CHIP;300ohm,1%,1/10W,TP,1608	1	SA
....5		2007-000763	R-CHIP;330ohm,1%,1/10W,TP,1608	1	SNA
....5		2007-000772	R-CHIP;33Kohm,1%,1/10W,TP,1608	1	SA
....5		2007-000779	R-CHIP;33ohm,1%,1/10W,TP,1608	6	SA
....5		2007-000831	R-CHIP;39Kohm,5%,1/16W,TP,1005	2	SA
....5		2007-000962	R-CHIP;5.1Kohm,1%,1/10W,TP,1608	3	SA
....5		2007-001038	R-CHIP;56Kohm,1%,1/10W,TP,1608	1	SA
....5		2007-001090	R-CHIP;620ohm,1%,1/10W,TP,1608	1	SA
....5		2007-001153	R-CHIP;750ohm,1%,1/10W,TP,1608	1	SA
....5		2007-001175	R-CHIP;8.2Kohm,1%,1/10W,TP,1608	1	SA
....5		2007-001199	R-CHIP;820ohm,1%,1/10W,TP,1608	1	SA
....5		2007-001298	R-CHIP;51ohm,5%,1/16W,TP,1005	6	SNA
....5		2007-001433	R-CHIP;12Kohm,1%,1/10W,TP,1608	2	SA
....5		2007-002797	R-CHIP;560ohm,5%,1/16W,TP,1005	1	SA
....5		2007-002900	R-CHIP;11Kohm,1%,1/10W,TP,1608	1	SNA
....5		2007-007107	R-CHIP;100Kohm,1%,1/16W,TP,1005	1	SNA
....5		2007-007136	R-CHIP;4.7Kohm,1%,1/16W,TP,1005	10	SNA
....5		2007-007156	R-CHIP;1ohm,5%,1/16W,TP,1005	2	SNA
....5		2007-007306	R-CHIP;100ohm,1%,1/16W,TP,1005	18	SNA
....5		2007-007309	R-CHIP;12Kohm,1%,1/16W,TP,1005,0.35	2	SA
....5		2007-007312	R-CHIP;20Kohm,1%,1/16W,TP,1005	1	SA
....5		2007-007316	R-CHIP;3.3Kohm,1%,1/16W,TP,1005	2	SNA
....5		2007-007318	R-CHIP;1Kohm,1%,1/16W,TP,1005	11	SNA
....5		2007-007517	R-CHIP;240ohm,1%,1/16W,TP,1005	3	SNA
....5		2007-007651	R-CHIP;9.1Kohm,1%,1/10W,TP,1608	2	SA
....5		2007-007698	R-CHIP;5.1Kohm,1%,1/16W,TP,1005	1	SNA
....5		2007-007721	R-CHIP;560ohm,1%,1/10W,TP,1608	1	SA
....5		2007-007766	R-CHIP;2Kohm,1%,1/16W,TP,1005	5	SNA
....5		2007-007798	R-CHIP;10ohm,1%,1/16W,TP,1005	32	SA
....5		2007-008015	R-CHIP;75ohm,1%,1/16W,TP,1005	18	SNA
....5		2007-008117	R-CHIP;2.7Kohm,1%,1/16W,TP,1005	1	SA

Exploded Views and Parts List

Level	Loc.	Part Code	Description & Specification	Qty.	SA/SNA
....5		2007-008596	R-CHIP;0.1ohm,1%,1/4W,TP,3216	1	SC
....5	AD480	2203-000257	C-CER,CHIP;10nF,10%,50V,X7R,TP,1608	1	SA
....5	AD480	2203-000489	C-CER,CHIP;2.2nF,10%,50V,X7R,TP,1005	3	SA
....5	AD480	2203-000995	C-CER,CHIP;0.047nF,5%,50V,C0G,TP,1005	2	SA
....5	AD480	2203-001126	C-CER,CHIP;0.68nF,10%,50V,X7R,TP,1608	1	SNA
....5	AD480	2203-001697	C-CER,CHIP;0.082nF,5%,50V,NP0,TP,1608	2	SA
....5	AD480	2203-001851	C-CER,CHIP;0.016nF,5%,50V,NP0,TP,1608	2	SNA
....5	AD480	2203-002711	C-CER,CHIP;100nF,10%,25V,X7R,TP,1608	3	SA
....5	AD480	2203-002982	C-CER,CHIP;6.8nF,10%,50V,X7R,TP,1005	1	SA
....5	AD480	2203-005138	C-CER,CHIP;1.8nF,10%,50V,X7R,TP,1005	3	SA
....5	AD480	2203-005249	C-CER,CHIP;100nF,10%,50V,X7R,TP,1608	12	SNA
....5	AD480	2203-005344	C-CER,CHIP;22nF,10%,25V,X7R,TP,1005,0.5T	3	SNA
....5	AD480	2203-005918	C-CER,CHIP;1000nF,10%,6.3V,X7R,TP,1608	2	SNA
....5	AD480	2203-006048	C-CER,CHIP;100nF,10%,10V,X7R,TP,1005	9	SA
....5	AD480	2203-006158	C-CER,CHIP;100nF,10%,16V,X7R,TP,1005,0.5	61	SNA
....5	AD480	2203-006320	C-CER,CHIP;2200nF,10%,16V,X7R,TP,2012	1	SNA
....5	AD480	2203-006348	C-CER,CHIP;1000nF,10%,25V,X5R,TP,1608,0.	3	SA
....5	AD480	2203-006427	C-CER,CHIP;4700nF,10%,16V,X5R,TP,2012	1	SA
....5	AD480	2203-006474	C-CER,CHIP;22000nF,20%,6.3V,X5R,TP,2012	6	SA
....5	AD480	2203-006562	C-CER,CHIP;1000nF,10%,10V,X5R,TP,1005	2	SNA
....5	AD480	2203-006698	C-CER,CHIP;1000nF,10%,25V,X7R,TP,1608,0.	12	SNA
....5	AD480	2203-006890	C-CER,CHIP;10000nF,20%,6.3V,X5R,TP,1608	8	SNA
....5	AD480	2203-006960	C-CER,CHIP;1000nF,10%,50V,X7R,TP,2012	1	SNA
....5	AD480	2203-007240	C-CER,CHIP;22000nF,20%,6.3V,X5R,TP,1608,	3	SA
....5	AD480	2203-007270	C-CER,CHIP;10000nF,10%,10V,X5R,TP,1608,0	13	SNA
....5	AD480	2203-007306	C-CER,CHIP;10000nF,10%,25V,X5R,TP,2012,1	31	SNA
....5		2409-001118	C-POLYMER ,CHIP;47uF,20%,10V,WT,TP,3.5X2	1	SA
....5		2409-001240	C-ORGANIC,SMD;33uF,20%,25V,LR,TP,7343(1.	1	SA
....5		2703-003747	INDUCTOR-SMD;22uH,20%,6060,0.135ohm,1300	2	SA
....5		2703-003803	INDUCTOR-SMD;4.7uH,20%,6060,0.031ohm,270	1	SA
....5		2703-003862	INDUCTOR-SMD;10uH,20%,6060,0.065ohm,1900	1	SA
....5		2703-003867	INDUCTOR-SMD;22uH,20%,4040,1.8T,0.29Ohm,	1	SA
....5		2703-003937	INDUCTOR-SMD;1uH,20%,7.0x6.47x3.0mm,0.00	1	SA
....5		2703-004199	INDUCTOR-SMD;10uH,20%,7066,2.2mm,0.101Oh	1	SNA
....5		2801-003954	CRYSTAL-SMD;27MHz,30ppm,28-AAN,16pF,50oh	1	SA
....5		3301-002039	BEAD-SMD;26ohm,1608,TP	24	SA
....5		3601-001386	FUSE-SURFACE MOUNT;125V,5A,FAST-ACTING,C	1	SA
....5		3708-002157	CONNECTOR-FPC/FFC/PIC;80P,0.5mm,SMD-A,AU	2	SNA
....5	EH01	3711-005601	HEADER-BOARD TO CABLE;BOX,8P,1R,2mm,SMD-	1	SA
....5	EH01	3711-005925	HEADER-BOARD TO CABLE;BOX,51P,1R,0.5mm,S	1	SA

Level	Loc.	Part Code	Description & Specification	Qty.	SA/SNA
....5		6302-001290	GASKET;SMR-TS-4-4.5-3,4.0mm,Ni+Au+SUS+Mg	4	SNA
....5		BN41-01939B	PCB MAIN;2013 FHD 120Hz/240Hz,FR-4,4,1.2	1	SNA
....5		BN97-07139A	ASSY MICOM;F55A1F012,2013.02.05,EEPROM	1	SNA
....6		1107-002224	IC-FLASH MEMORY;W25X40CLSSIG,4Mbit,SOP,8	1	SNA
..3	TC-OC	BN96-24429A	ASSY CABLE P-FFC;E6K(3D), E7K(3D),FFC,57	2	SNA
..3		BN96-24848A	ASSY OPEN CELL;LSF550HJ02-A,8bit,55 INCH	1	SNA
..4		BN81-07434A	A/S-ADHESIVE-A.C.F(CP);ADHESIVE-A.C.F,1-	1	SNA
..4		BN81-07466A	A/S-IC DRIVER GATE;IC DRIVER GATE,2-IC D	1	SNA
..4		BN81-07883A	A/S-IC DRIVER SOURCE;IC DRIVER SOURCE,13	1	SNA
..4		BN81-07897A	A/S-POLARIZER-C/F;8-POLARIZER-C/F	1	SNA
..4		BN81-07908A	A/S-POLARIZER-TFT;POLARIZER-TFT	1	SNA
..4		BN81-07933B	A/S-ASSY PCB-SOURCE LEFT;ASSY PCB-SOURCE	1	SNA
..4		BN81-07934B	A/S-ASSY PCB-SOURCE RIGHT;ASSY PCB-SOURC	1	SNA
..4		BN81-07943A	A/S-ADHESIVE-A.C.F(TP500B);ADHESIVE-A.C.	1	SNA
..3	TC01A	BN96-25290A	ASSY MISC P-CHASSIS TOP;Y13 SF-LED 55(6.	1	SA
..4		BN60-00667A	SPACER-GASKET;Y13 SF-LED,GASKET(FG200A),	6	SNA
..4		BN60-00701J	SPACER-TOP,UD;Y13 Slim F-LED 55,GASKET*,	2	SNA
..4		BN60-00701K	SPACER-TOP,LR;Y13 Slim F-LED 55,GASKET*,	2	SNA
..4		BN60-00715A	SPACER-TOP,CORNER;Y13 Slim F-LED,GASKET*	4	SNA
..4		BN63-07556U	COVER-SHEET;F-LED,urethane,T0.068,W18,10	1	SNA
..4		BN63-10945B	COVER-SHEET;Y13 SF-LED,PO-SHEET,T0.068,W	3	SNA
..4	AC157	BN64-02196A	CHASSIS-TOP;Y13 F-LED Slim 55",PC+ABS+G/	1	SNA
..3		BN96-26729A	ASSY MISC P-SHIELD SOURCE,PCB;Y13 SF-LED	1	SNA
..4		BN62-00379G	INSULATION CABI-SHILED FHD L;Y13 SLIM 55	1	SNA
..3		BN96-26729B	ASSY MISC P-SHIELD SOURCE,PCB_R;Y13 SF-L	1	SNA
..4		BN02-00152A	TAPE ETC-SHEET FIXING;Y13 Slim F-LED,PET	3	SNA
..4		BN62-00379H	INSULATION CABI-SHILED FHD R;Y13 SF-LED	1	SNA
..4		BN63-10492A	SHIELD-SOURCE PCB;Y13 SF-LED 55",EGI-SEC	1	SNA
1	M0017	BN91-10279Z	ASSY CHASSIS;F6100,55,XC	1	SNA
..2	M0014	BN94-06165Z	ASSY PCB MAIN;F6100,55,XC	1	SA
..3		BN61-09059A	HOLDER-SIDE AV;UF6100,HIPS,BK0020,HB,EO/	1	SNA
..4		0103-004628	RESIN-HIPS;HF-1690H,K2901,BK0020,1.5mm H	13	SNA
..3		BN62-00368A	PAD GAP;F5000,SILICON,40*40 mm,6.5,Light	1	SNA
..3		BN97-07019F	ASSY SMD;F6100	1	SNA
..4		0202-001899	SOLDER-CREAM;M705-GRN360-K2-VT,25-36um,S	8	SNA
..4	DS01A	0401-001056	DIODE-SWITCHING;MMBD4148SE,100V,200mA,SO	1	SA
..4		0403-001783	DIODE-ZENER;BZB84-C6V2,5.8/6.6V,300mW,SO	4	SNA
..4		0403-001785	DIODE-ZENER;NZH5V1B,4.94/5.2V,500mW,SOD-	1	SA
..4		0403-001797	DIODE-ZENER;NZH3V0B,2.85/3.15V,500mW,SOD	1	SNA
..4		0404-001404	DIODE-SCHOTTKY;BAT721C,40V,200mA,SOT-23,	1	SA

Exploded Views and Parts List

Level	Loc.	Part Code	Description & Specification	Qty.	SA/SNA
...4		0406-001200	DIODE-TVS;RCLAMP0504F,6/-V,150W,SC-70	1	SA
...4		0406-001271	DIODE-TVS;RCLAMP0524P,6/-V,150W,SLP251	4	SNA
...4	DS01A	0407-000114	DIODE-SWITCHING;KDS184,80V,100mA,SOT-23,	1	SNA
...4		0501-000279	TR-SMALL SIGNAL;KSA1182-Y,PNP,150mW,SOT-	1	SA
...4		0501-000445	TR-SMALL SIGNAL;KTC3875S-Y,NPN,150mW,SOT	11	SC
...4		0505-000110	FET-SILICON;2N7002,N,60V,115mA,7.5ohm,0.	5	SA
...4		0505-002560	FET-SILICON;AO6415,P,-20V,-3.3A,0.15ohm,	1	SA
...4		0801-002630	IC-CMOS LOGIC;74AHCT1G08,2-INPUT AND GAT	1	SA
...4		0801-002780	IC-CMOS LOGIC;74LVC1G17,SCHMITT-TRIGGER	2	SA
...4		0801-003330	IC-CMOS LOGIC;Octal buffer,DQFN,20P,4.5x	4	SA
...4		0802-001012	IC-CMOS LOGIC;74LCX245,TRANSCEIVER,DQFN,	1	SNA
...4		1001-001545	IC-ANALOG MULTIPLEX;TS3USB221ERSER,R-PQF	1	SA
...4		1103-001531	IC-EEPROM;S-24C256CI-J8T1U4,256Kbit,32Kx	1	SA
...4		1103-001561	IC-EEPROM;S-24C02DI-J800,2Kbit,256X8bit,	1	SA
...4		1105-002227	IC-DDR3 SDRAM;K4B1G1646G-BCK0,DDR3 SDRAM	2	SA
...4		1201-003183	IC-AUDIO AMP;DRV612,HTSSOP,14P,5x4.4mm,D	1	SA
...4		1201-003333	IC-POWER AMP;NTP-7412S,MLF,48P,7x7mm,DUA	1	SA
...4		1203-006109	IC-POSI.FIXED REG.;S-1206B33-M3T1G,SOT-2	1	SA
...4		1203-006130	IC-POSI.FIXED REG.;S-1172B25-U5T1G,SOT-8	1	SA
...4		1203-006135	IC-POSI.FIXED REG.;AP1117D-33-GZ-13-89,T	1	SA
...4		1203-006136	IC-POSI.FIXED REG.;AP1117D-18-GZ-13-89,T	1	SA
...4		1203-006138	IC-POSI.ADJUST REG.;AP1117DGZ-13-89,TO-2	1	SA
...4		1203-006684	IC-DC/DC CONVERTER;TPS54327DDAR,HSOP8,8P	2	SNA
...4		1203-007249	IC-SWITCH CUR. REG.;TPS62561DDC,DDA,5P,3	1	SA
...4		1203-007680	IC-DC/DC CONVERTER;BD86103AFJ,SOP-J8,8Q,	1	SA
...4		1203-007728	IC-VOL. DETECTOR;RT9831GQW,QW : WQFN-20L	1	SA
...4		1204-003443	IC-DECODER;NT72569,LFBGA,620Z30,21x21mm,	1	SA
...4		1205-003201	IC-BUS SWITCH;TC7WB125FK,SSOP,8P,2x2.3mm	1	SA
...4		1405-001271	VARISTOR;35V,20Vdc,5A,1.0x0.5x0.6mm,TP,1	23	SA
...4		2007-000137	R-CHIP;2Kohm,5%,1/16W,TP,1005	2	SNA
...4		2007-000138	R-CHIP;100ohm,5%,1/16W,TP,1005	30	SA
...4		2007-000140	R-CHIP;1Kohm,5%,1/16W,TP,1005	1	SNA
...4		2007-000142	R-CHIP;2.7Kohm,5%,1/16W,TP,1005	3	SNA
...4		2007-000143	R-CHIP;4.7Kohm,5%,1/16W,TP,1005	70	SNA
...4		2007-000148	R-CHIP;10Kohm,5%,1/16W,TP,1005	47	SA
...4		2007-000149	R-CHIP;12Kohm,5%,1/16W,TP,1005	1	SA
...4		2007-000153	R-CHIP;22Kohm,5%,1/16W,TP,1005	6	SNA
...4		2007-000157	R-CHIP;47Kohm,5%,1/16W,TP,1005	8	SNA
...4		2007-000162	R-CHIP;100Kohm,5%,1/16W,TP,1005	5	SNA
...4		2007-000168	R-CHIP;470Kohm,5%,1/16W,TP,1005	1	SNA

Level	Loc.	Part Code	Description & Specification	Qty.	SA/SNA
...4		2007-000170	R-CHIP;1Mohm,5%,1/16W,TP,1005	1	SNA
...4		2007-000172	R-CHIP;10ohm,5%,1/16W,TP,1005	2	SNA
...4		2007-000173	R-CHIP;22ohm,5%,1/16W,TP,1005	3	SNA
...4		2007-000174	R-CHIP;47ohm,5%,1/16W,TP,1005	2	SNA
...4		2007-000336	R-CHIP;120Kohm,1%,1/10W,TP,1608	1	SA
...4		2007-000691	R-CHIP;3.3Mohm,5%,1/10W,TP,1608	1	SA
...4		2007-000695	R-CHIP;3.3ohm,5%,1/10W,TP,1608	4	SNA
...4		2007-000726	R-CHIP;300ohm,1%,1/10W,TP,1608	2	SA
...4		2007-000775	R-CHIP;33Kohm,5%,1/16W,TP,1005	1	SNA
...4		2007-000803	R-CHIP;36Kohm,1%,1/10W,TP,1608	1	SA
...4		2007-000816	R-CHIP;390Kohm,1%,1/10W,TP,1608	1	SNA
...4		2007-000857	R-CHIP;4.3Kohm,1%,1/10W,TP,1608	5	SNA
...4		2007-000932	R-CHIP;470ohm,5%,1/16W,TP,1005	5	SNA
...4		2007-000979	R-CHIP;5.6Kohm,1%,1/10W,TP,1608	1	SA
...4		2007-001292	R-CHIP;33ohm,5%,1/16W,TP,1005	14	SNA
...4		2007-001298	R-CHIP;51ohm,5%,1/16W,TP,1005	2	SNA
...4		2007-001313	R-CHIP;330ohm,5%,1/16W,TP,1005	2	SNA
...4		2007-001320	R-CHIP;1.8Kohm,5%,1/16W,TP,1005	2	SA
...4		2007-001325	R-CHIP;3.3Kohm,5%,1/16W,TP,1005	1	SNA
...4		2007-002912	R-CHIP;33.2Kohm,1%,1/10W,TP,1608	1	SA
...4		2007-007009	R-CHIP;75ohm,5%,1/16W,TP,1005	2	SA
...4		2007-007095	R-CHIP;390ohm,5%,1/16W,TP,1005	1	SA
...4		2007-007135	R-CHIP;18Kohm,1%,1/16W,TP,1005	2	SNA
...4		2007-007136	R-CHIP;4.7Kohm,1%,1/16W,TP,1005	3	SNA
...4		2007-007142	R-CHIP;10Kohm,1%,1/16W,TP,1005	4	SNA
...4		2007-007156	R-CHIP;1ohm,5%,1/16W,TP,1005	25	SNA
...4		2007-007238	R-CHIP;8.25Kohm,1%,1/10W,TP,1608	1	SA
...4		2007-007306	R-CHIP;100ohm,1%,1/16W,TP,1005	4	SNA
...4		2007-007311	R-CHIP;22Kohm,1%,1/16W,TP,1005	2	SA
...4		2007-007317	R-CHIP;2.2Kohm,1%,1/16W,TP,1005	1	SA
...4		2007-007318	R-CHIP;1Kohm,1%,1/16W,TP,1005	22	SNA
...4		2007-007331	R-CHIP;90.9Kohm,1%,1/10W,TP,1608	1	SA
...4		2007-007463	R-CHIP;1.1Kohm,1%,1/16W,TP,1005	1	SA
...4		2007-007517	R-CHIP;240ohm,1%,1/16W,TP,1005	3	SNA
...4		2007-007528	R-CHIP;1.5Kohm,1%,1/16W,TP,1005	1	SA
...4		2007-007538	R-CHIP;56Kohm,1%,1/16W,TP,1005	1	SA
...4		2007-008015	R-CHIP;75ohm,1%,1/16W,TP,1005	12	SNA
...4		2007-008133	R-CHIP;56.2Kohm,1%,1/10W,TP,1608	1	SA
...4		2007-008137	R-CHIP;24Kohm,1%,1/16W,TP,1005	3	SNA
...4		2007-008142	R-CHIP;511Kohm,1%,1/10W,TP,1608	1	SA

Exploded Views and Parts List

Level	Loc.	Part Code	Description & Specification	Qty.	SA/SNA
...4		2007-008332	R-CHIP;11.5Kohm,1%,1/16W,TP,1005	1	SA
...4		2007-008426	R-CHIP;12.4Kohm,1%,1/10W,TP,1608	1	SA
...4		2007-008649	R-CHIP;220ohm,1%,1/16W,TP,1005	1	SNA
...4		2007-008779	R-CHIP;0ohm,1%,1/16W,TP,1005	3	SA
...4		2007-008807	R-CHIP;53.6Kohm,1%,1/16W,TP,1005	1	SA
...4		2011-001261	R-NETWORK;33ohm,5%,1/16W,L,CHIP,8P,TP,2.	6	SA
...4		2011-001262	R-NETWORK;22ohm,5%,1/16W,L,CHIP,8P,TP,2.	10	SA
...4		2011-001264	R-NETWORK;10ohm,5%,1/16W,L,CHIP,8P,TP,2.	4	SNA
...4		2011-001344	R-NETWORK;100ohm,5%,1/16W,L,CHIP,8P,TP,2	3	SA
...4		2011-001449	R-NETWORK;22ohm,5%,1/16W,L,4P,TP,1010	5	SA
...4		2011-001519	R-NETWORK;33OHM,5%,1/16W,L,CHIP,4P,TP,1.	2	SA
...4	AD480	2203-000233	C-CER,CHIP;0.1nF,5%,50V,C0G,TP,1005	7	SA
...4	AD480	2203-000254	C-CER,CHIP;10nF,10%,16V,X7R,TP,1005	5	SA
...4	AD480	2203-000278	C-CER,CHIP;0.01nF,0.5pF,50V,C0G,TP,1005	4	SA
...4	AD480	2203-000359	C-CER,CHIP;0.15nF,5%,50V,C0G,TP,1005,0.5	2	SNA
...4	AD480	2203-000438	C-CER,CHIP;1nF,10%,50V,X7R,TP,1005	11	SA
...4	AD480	2203-000575	C-CER,CHIP;220nF,10%,25V,X7R,TP,2012	3	SNA
...4	AD480	2203-000627	C-CER,CHIP;0.022nF,5%,50V,C0G,TP,1005	2	SNA
...4	AD480	2203-000679	C-CER,CHIP;0.027nF,5%,50V,C0G,TP,1005	1	SA
...4	AD480	2203-000696	C-CER,CHIP;0.002nF,0.25pF,50V,C0G,TP,100	2	SA
...4	AD480	2203-000714	C-CER,CHIP;3.3nF,10%,50V,X7R,TP,1005	10	SA
...4	AD480	2203-000995	C-CER,CHIP;0.047nF,5%,50V,C0G,TP,1005	2	SA
...4	AD480	2203-001412	C-CER,CHIP;0.03nF,5%,50V,NP0,TP,1005	6	SNA
...4	AD480	2203-002285	C-CER,CHIP;10nF,10%,50V,X7R,TP,1005	10	SNA
...4	AD480	2203-002443	C-CER,CHIP;0.33nF,10%,50V,X7R,TP,1005	2	SA
...4	AD480	2203-005221	C-CER,CHIP;15nF,10%,50V,X7R,TP,1608	1	SNA
...4	AD480	2203-005249	C-CER,CHIP;100nF,10%,50V,X7R,TP,1608	15	SNA
...4	AD480	2203-005481	C-CER,CHIP;47nF,10%,10V,X7R,TP,1005	6	SA
...4	AD480	2203-005659	C-CER,CHIP;0.18nF,5%,50V,NP0,TP,1005	1	SNA
...4	AD480	2203-006048	C-CER,CHIP;100nF,10%,10V,X7R,TP,1005	108	SA
...4	AD480	2203-006307	C-CER,CHIP;1000nF,10%,25V,X5R,TP,2012	2	SNA
...4	AD480	2203-006324	C-CER,CHIP;2200nF,10%,10V,X5R,TP,1608	4	SA
...4	AD480	2203-006361	C-CER,CHIP;10000nF,10%,10V,X5R,TP,2012	15	SC
...4	AD480	2203-006474	C-CER,CHIP;22000nF,20%,6.3V,X5R,TP,2012	19	SA
...4	AD480	2203-006562	C-CER,CHIP;1000nF,10%,10V,X5R,TP,1005	13	SNA
...4	AD480	2203-006838	C-CER,CHIP;2200nF,10%,6.3V,X5R,TP,1005	3	SA
...4	AD480	2203-006842	C-CER,CHIP;0.47nF,5%,50V,C0G,TP,1005	5	SNA
...4	AD480	2203-006890	C-CER,CHIP;10000nF,20%,6.3V,X5R,TP,1608	26	SNA
...4	AD480	2203-006992	C-CER,CHIP;0.33nF,5%,50V,C0G,TP,1005	8	SNA
...4	AD480	2203-007176	C-CER,CHIP;10000nF,10%,16V,X5R,TP,2012,1	6	SNA

Level	Loc.	Part Code	Description & Specification	Qty.	SA/SNA
...4	AD480	2203-007370	C-CER,CHIP;10000nF,10%,10V,X7R,TP,2012	2	SA
...4	AD480	2203-007513	C-CER,CHIP;10000nF,10%,10V,X5R,TP,1608,0	15	SA
...4		2703-000158	INDUCTOR-SMD;1uH,10%,2012,.40ohm,50mA,45,	3	SA
...4		2703-001209	INDUCTOR-SMD;1.2uH,10%,1608,.80ohm,25mA,3	3	SA
...4		2703-002332	INDUCTOR-SMD;330nH,5%,1608,30ohm,100mA,32	1	SA
...4		2703-003149	INDUCTOR-SMD;2.2uH,20%,5050,0.055Ohm,300	2	SA
...4		2703-003343	INDUCTOR-SMD;2.2uH,20%,2520,0.104Ohm,130	1	SNA
...4		2703-003407	INDUCTOR-SMD;120nH,5%,1608,1.20ohm,300mA,	2	SA
...4		2703-003930	INDUCTOR-SMD;4.7uH,20%,5050,0.072Ohm,245	5	SA
...4		2801-003773	CRYSTAL-SMD;12MHz,30ppm,28-AAN,20pF,50oh	1	SA
...4		3301-002039	BEAD-SMD;26ohm,1608,TP	53	SA
...4		3701-001861	CONNECTOR-HDMI;19P,2ROW,FEMALE,SMD-A,AU	2	SA
...4		3707-001106	CONNECTOR-OPTICAL;STRAIGHT W/L,SPDIF	1	SA
...4		3708-003073	CONNECTOR-FPC/FFC/PIC;51P,0.5mm,SMD,AU,N	1	SNA
...4		3709-001712	CONNECTOR-CARD SLOT;68P,1.27mm,ANGLE,AU,	1	SA
...4	EH01	3711-007742	HEADER-BOARD TO CABLE;BOX,20P,2R,2mm,ANG	2	SA
...4	EH01	3711-008131	HEADER-BOARD TO CABLE;BOX,4P,1R,2.5mm,AN	1	SA
...4		3722-003457	JACK-USB;4P/1C,NI,BLK,A	1	SA
...4		3722-003546	JACK-PIN;5P+Screw hole,NI+SN,G,Y/BLU/RED	1	SA
...4		3722-003655	JACK-SCART;21P,SN,BLK	1	SA
...4		3722-003667	JACK-PHONE;1P/7C,AU/NI,BLK,STRAIGHT	1	SA
...4	ET01	BN40-00256A	TUNER;DTOS40EIH035A,DTOS40EIH035A,DVB-TC	1	SA
...4		BN41-01954A	PCB MAIN;NT13 ISDB-T,FR-4,4,1.2T,158*193	1	SNA
...4		BN97-06502F	ASSY MICOM-SUB;T-NVTFAEUS,NT13 EU (F4500	1	SNA
....5		1107-002226	IC-NOR FLASH;W25Q40CLSSIP,4Mbit,SOIC,8P,	1	SNA
...4		BN97-06502K	ASSY MICOM;T-NVTF6DEUC,NT13 EU4 (F4500/F	1	SNA
....5		1107-002049	IC-NAND FLASH;K9F1G08U0D-SCB0,1Gbit,128M	1	SNA
....5		BN46-00316E	S/W-E-MANUAL;NOVATEK13,EU4,XC,XN,ZF,ZG,Z	1	SNA
....5		BN46-00323A	S/W MICOM;T-NVTF6DEUC-XXXX,2012.11.19	1	SNA
..3		BN97-07120A	ASSY DRM;EUROPE	1	SNA
...4		BN46-00328A	KEY CODE;KEY CODE-CERTIFI:CI+,TV,NT13,eu	1	SNA
1		BN92-11712M	ASSY BOX;UF6K	1	SNA
.2		BH68-00662A	LABEL BOX-00;ALL MODEL,paper,60,110,WHT,	1	SNA
.2		BN69-08511A	BOX-01,SET,IN;55UF64000-QS,CB,C-01,DW1,Y	1	SNA
.2		BN69-08543G	BOX-01,SET;55UF6100-QS,CB,C-03,DW3,YEL,W	1	SNA
1		BN92-11718A	ASSY P/MATERIAL;UF6000 46	1	SNA
.2		6902-000379	BAG AIR;LDPE,T0.2,W1000,L1800,TRP,1260.0	1	SNA
.2		6922-000003	BAND PP;PP,T0.8,W18,L1650M,TRP,DA69-9014	1	SNA
.2	T0214	AA61-20285C	HOLDER-BOX;CORAL,PP,BLACK,HB,17.5g	4	SNA
.2		BN69-03982M	PAD PACKING-EDGE;EDGE,PAPER,-,T5,W120,L2	1	SNA

Exploded Views and Parts List

Level	Loc.	Part Code	Description & Specification	Qty.	SA/SNA
.2		BN69-05418A	PACKING-BAG WRAPPING;-LDPE,-,0,019,500,	3	SNA
.2		BN69-06642B	PACKING-PAD;PAD,PAPER,-,-,CB-SW4,1500,11	1	SNA
.2		BN69-06675A	PACKING-SHEET PALLET;PACKING SHEET PALLE	1	SNA
.2		BN69-06679A	PACKING-BAG SHEET ROLL;-CB,-,FOAM 0,5mm	3	SNA
.2		BN69-08095N	PALLET;F61-65 55",WOOD,20mm,1155,1550,14	1	SNA
.2		BN69-08275A	CUSHION-SET;UF6200, 55 ,WW,EPS	1	SNA
.2		BN69-08417A	CUSHION-FRONT;UF8000 55",EPS	1	SNA
.2		BN74-00008D	TAPE-OPP MASKING;OPP,T0.05,W75,L800M,CLR	2	SNA
1	ACCE1	BN92-11797H	ASSY ACCESSORY;F6100	1	SNA
.2		BN68-04776D	LABEL-STICKER;UF6M,EDC,PET,T0.1,60,125,E	1	SNA
.2		BN96-25424W	ASSY ACCESSORY MANUAL/CABLE;UE55F6100AWX	1	SNA
..3	T0268	3903-000849	CBF-POWER CORD;DT,CEE,LP-21L,250V,2.5A,B	1	SA
..3		4301-000121	BATTERY-MN;1.5V,R03,10.5x44.5m,HOLDER,7.	2	SNA
..3	REMO2	AA59-00743A	REMOCON;TM1240,44,3.0V,F6100/EU	1	SA
..3		BN61-08370A	HOLDER-WIRE STAND;26UE4000 GIUDE STAND,N	1	SNA
..3	M9889	BN63-01798B	CLOTH-CLEAN;CLOTH,180,200,sea blue,ToC	1	SNA
..3		BN68-00514K	MANUAL FLYER-02,WARRANTY CARD;comm,Samsu	1	SNA
..3		BN68-04735A	LABEL-E,PASS;ALL MODEL,ART PAPER 90G,50,	1	SNA
..3		BN68-04898N	LEAFLET-02,STAND GUIDE;UF6100,EU N.AFRIC	1	SNA
..3		BN68-04906E	MANUAL USERS-02;UF6100,ENG/FRA/DEU/DUT,X	1	SNA
..3		BN68-04972A	MANUAL FLYER-01,REGULATORY GUIDE;ALL,SAM	1	SNA
..3		BN68-05115H	LEAFLET-02,FICHE(UF6100);UF6100,EUROPE,W	1	SNA
..3		BN69-08226B	BOX-01,ACCESSORY;E7000,PAPER,CCP 400g,NO	1	SNA
..3		BN69-08472A	PAD-02,TYPE;ACCESSORY,CB,Black Paper 400	1	SNA
..3		BN69-08751D	WRAP VINYL-SHRINK;ACCESSORY BOX,PLASTIC	0	SNA
..3	EH03A	BN96-18153A	ASSY HOLDER P-RING;11 LED-TV	1	SNA
...4		6902-001404	BAG ZIPPER;LDPE,T0.05,W80,L100,TRP	1	SNA
...4	AH365	BN61-07295A	HOLDER-RING;40UD5500,ABS,BK0007,HB	4	SNA
.2	3DGLA	BN96-25614A	ASSY ACCESSORY 3D GLASSES;SSG-5100GB,In	1	SA
1		BN92-12048K	ASSY LABEL;6100,ZK	1	SNA
.2	T0527	BP68-00052B	LABEL-00,RATING;FPTV,PET,T0.05,93,73	1	SNA



**This Service Manual is a property of Samsung Electronics Co.,Ltd.
Any unauthorized use of Manual can be punished under applicable
International and/or domestic law.**

**© 2013 Samsung Electronics Co.,Ltd.
All rights reserved.
Printed in Korea**